

Errata

Title & Document Type: 8672A Operating Manual - June 1987

Manual Part Number: 08672-90117

Revision Date: June 1987

HP References in this Manual

This manual may contain references to HP or Hewlett-Packard. Please note that Hewlett-Packard's former test and measurement, semiconductor products and chemical analysis businesses are now part of Agilent Technologies. We have made no changes to this manual copy. The HP XXXX referred to in this document is now the Agilent XXXX. For example, model number HP8648A is now model number Agilent 8648A.

About this Manual

We've added this manual to the Agilent website in an effort to help you support your product. This manual provides the best information we could find. It may be incomplete or contain dated information, and the scan quality may not be ideal. If we find a better copy in the future, we will add it to the Agilent website.

Support for Your Product

Agilent no longer sells or supports this product. You will find any other available product information on the Agilent Test & Measurement website:

www.tm.agilent.com

Search for the model number of this product, and the resulting product page will guide you to any available information. Our service centers may be able to perform calibration if no repair parts are needed, but no other support from Agilent is available.

HP 8672A

SYNTHESIZED SIGNAL GENERATOR

2.0 - 18.0 GHz

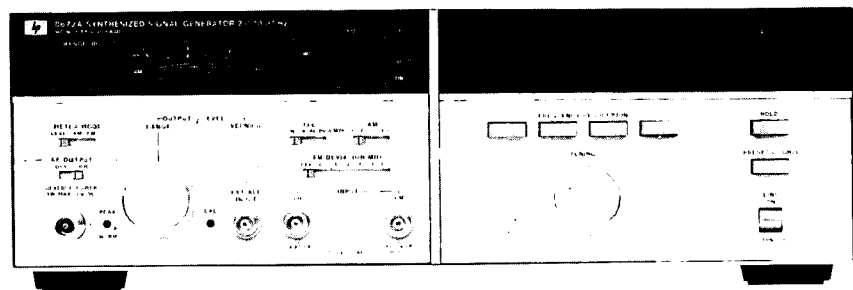

CERTIFICATION

Hewlett-Packard Company certifies that this product met its published specifications at the time of shipment from the factory. Hewlett-Packard further certifies that its calibration measurements are traceable to the United States National Bureau of Standards, to the extent allowed by the Bureau's calibration facility, and to the calibration facilities of other International Standards Organization members.

WARRANTY

This Hewlett-Packard instrument product is warranted against defects in material and workmanship for a period of one year from date of shipment, except that in the case of certain components listed in Section I of this manual, the warranty shall be for the specified period. During the warranty period, Hewlett-Packard Company will, at its option, either repair or replace products which prove to be defective.

For warranty service or repair, this product must be returned to a service facility designated by HP. Buyer shall prepay shipping charges to HP and HP shall pay shipping charges to return the product to Buyer. However, Buyer shall pay all shipping charges, duties, and taxes for products returned to HP from another country.

HP warrants that its software and firmware designated by HP for use with an instrument will execute its programming instructions when properly installed on that instrument. HP does not warrant that the operation of the instrument, or software, or firmware will be uninterrupted or error free.

LIMITATION OF WARRANTY

The foregoing warranty shall not apply to defects resulting from improper or inadequate maintenance by Buyer, Buyer-supplied software or interfacing, unauthorized modification or misuse, operation outside of the environmental specifications for the product, or improper site preparation or maintenance.

NO OTHER WARRANTY IS EXPRESSED OR IMPLIED. HP SPECIFICALLY DISCLAIMS THE IMPLIED WARRANTIES OF MERCHANTABILITY AND FITNESS FOR A PARTICULAR PURPOSE.

EXCLUSIVE REMEDIES

THE REMEDIES PROVIDED HEREIN ARE BUYER'S SOLE AND EXCLUSIVE REMEDIES. HP SHALL NOT BE LIABLE FOR ANY DIRECT, INDIRECT, SPECIAL, INCIDENTAL, OR CONSEQUENTIAL DAMAGES, WHETHER BASED ON CONTRACT, TORT, OR ANY OTHER LEGAL THEORY.

ASSISTANCE

Product maintenance agreements and other customer assistance agreements are available for Hewlett-Packard products.

For any assistance, contact your nearest Hewlett-Packard Sales and Service Office. Addresses are provided at the back of this manual.

HP 8672A

SYNTHESIZED SIGNAL GENERATOR

2.0 — 18.0 GHz

SERIAL NUMBERS

This manual applies to instruments with serial numbers prefixed 2708A and above.

For additional important information about serial numbers, see INSTRUMENTS COVERED BY THIS MANUAL in Section I.



© Copyright HEWLETT-PACKARD COMPANY 1987
1501 PAGE MILL ROAD, PALO ALTO, CALIFORNIA, U.S.A.

OPERATING MANUAL PART NO. 08672-90117
Operating Manual Microfiche Part No. 08672-90019
Service Manual Part No. 08672-90118
Service Manual Microfiche Part No. 08672-90120

Printed: June 1987

CONTENTS

	Page		Page
Section I			
GENERAL INFORMATION			
Introduction	1-1	ALC (Automatic Level Control)	3-3
Specifications	1-1	Modulation	3-3
Safety Considerations	1-1	Detailed Operating Instructions	3-4
Instruments Covered by this Manual	1-1	ALC Control	3-4
Manual Changes Supplement	1-1	Amplitude Modulation	3-8
Description	1-2	Frequency Control	3-10
Remote Operation	1-2	Frequency Modulation	3-14
Selecting the HP-IB Address	1-3	Level Control	3-17
Options	1-3	Peak-Norm Adjustment	3-20
Electrical Options	1-3	RF ON/OFF Switch	3-21
Mechanical Options	1-3	Remote Operation	3-22
Accessories Supplied	1-3	HP-IB Compatibility	3-22
Equipment Required but not Supplied	1-4	Remote Mode	3-22
Electrical Equipment Available	1-4	Local Mode	3-22
Recommended Test Equipment	1-4	Addressing	3-22
Section II			
INSTALLATION			
Introduction	2-1	Data Messages	3-22
Initial Inspection	2-1	Receiving Data Messages	3-24
Preparation for Use	2-1	Receiving the Clear Message	3-24
Power Requirements	2-1	Receiving the Trigger Message	3-25
Line Voltage and Fuse Selection	2-1	Receiving the Remote Message	3-25
Power Cables	2-1	Receiving the Local Message	3-25
HP-IB Address Selection	2-2	Receiving the Local Lockout Message	3-25
Interconnections	2-3	Receiving the Clear Lockout/ Set Local Message	3-25
Mating Connectors	2-3	Receiving the Pass Control Message	3-25
Operating Environment	2-3	Sending the Require Service Message	3-25
Bench Operation	2-4	Sending the Status Byte Message	3-25
Rack Mounting	2-4	Sending the Status Bit Message	3-25
Storage and Shipment	2-4	Receiving the Abort Message	3-25
Environment	2-4	Operator's Checks	3-28
Packaging	2-4	Basic Functional Checks	3-28
Section III			
OPERATION			
Introduction	3-1	HP-IB Functional Checks	3-34
Panel Features	3-1	Section IV	
Operating Characteristics	3-1	PERFORMANCE TESTS	
Local Operation	3-1	Introduction	4-1
Remote Operation	3-1	Abbreviated Performance Test	4-1
Operator's Checks	3-1	Calibration Cycle	4-1
Operator's Maintenance	3-1	Performance Test Record	4-1
Turn-On Instructions	3-1	Equipment Required	4-1
Turn-On	3-1	Test Procedures	4-1
Frequency Standard Selection	3-1	Frequency Range and Resolution Test	4-2
Simplified Operation	3-3	Frequency Switching Time Test	4-5
Frequency	3-3	Output Level, High Level Accuracy and Flatness Test	4-11
Output Level	3-3	Low Level Accuracy Test	4-16
		Output Level Switching Time Test	4-20
		Harmonics, Subharmonics, & Multiples Tests	4-23
		Non-Harmonically Related Spurious Signals Tests	4-26
		Power Line Related Spurious Signals Tests	4-28

CONTENTS (cont'd)

	Page		Page
Single-Sideband Phase Noise Test	4-31	AM Distortion	4-47
External FM Accuracy and Meter Accuracy	4-36	External AM Accuracy and Meter Accuracy	4-49
FM Frequency Response	4-38	AM Bandwidth	4-52
FM Harmonic and Non-Harmonic Distortion	4-40	Incidental AM	4-54
Residual FM	4-42	Internal Time Base Aging Rate	4-56
Incidental FM	4-45		

ILLUSTRATIONS

	Page		Page
Figure		Figure	
1-1. HP 8672A Accessories Supplied and Options 907, 908 and 909	1-0	4-4. Amplitude Recovery Measurement Waveform	4-10
2-1. Line Voltage and Fuse Selection	2-2	4-5. Output Level, High Level Accuracy and Flatness Test Setup	4-12
2-2. Power Cable and Mains Plug Part Numbers	2-2	4-6. Low Level Accuracy Test Setup	4-17
2-3. HP-IB Address Switch Factory Settings	2-3	4-7. Output Level Switching Time Test Setup ..	4-20
2-4. Hewlett-Packard Interface Bus Connection	2-5	4-8. Output Level Switching Time Measurement Waveform	4-22
3-1. Front Panel Features	3-2	4-9. Harmonic, Subharmonics, and Multiples Test Setup	4-23
3-2. Rear Panel Features	3-2	4-10. Non-Harmonically Related Spurious Signals Test Setup	4-26
3-3. External Leveling with a Crystal Detector ..	3-4	4-11. Power Line Related Spurious Signals Test Setup	4-29
3-4. External Leveling with a Power Meter	3-5	4-12. Single-Sideband Phase Noise Test Setup ..	4-32
3-5. Frequency Programming Codes and Arguments	3-12	4-13. External FM Accuracy and Meter Accuracy Test Setup	4-36
3-6. Frequency Switching Time Showing Worst Case	3-13	4-14. FM Frequency Response Test Setup	4-38
3-7. Possible FM Rates and Frequency Deviations	3-16	4-15. FM Harmonic and Non-Harmonic Distortion Test Setup	4-40
3-8. Frequency Checks Test Setup	3-29	4-16. Residual FM Test Setup	4-42
3-9. AM Check Test Setup	3-32	4-17. Incidental FM Test Setup	4-45
3-10. FM Check Test Setup	3-33	4-18. AM Distortion Test Setup	4-47
4-1. Frequency Range and Resolution Test Setup	4-2	4-19. External AM Accuracy and Meter Accuracy Test Setup	4-49
4-2. Frequency Switching Time Test Setup	4-6	4-20. AM Bandwidth Test Setup	4-52
4-3. Frequency Switching Time Measurement Waveform	4-8	4-21. Incidental AM Test Setup	4-54
		4-22. Internal Time Base Aging Rate Test Setup	4-56

TABLES

	Page		Page
Table		Table	
1-1. Specifications	1-5	3-3. Message Reference Table	3-23
1-2. Supplemental Characteristics	1-9	3-4. Programming Quick Reference Guide	3-26
1-3. Recommended Test Equipment	1-10		
2-1. Allowable HP-IB Address Codes	2-3	4-1. Output Level, High Level Accuracy and Flatness Test Record	4-14
3-1. Operating Characteristics	3-1	4-2. Low Level Accuracy Test Record	4-19
3-2. Index of Detailed Operating Instructions	3-1	4-3. Harmonics, Subharmonics & Multiples Test Record	4-25
		4-4. Performance Test Record	4-58

SAFETY CONSIDERATIONS

GENERAL

This product and related documentation must be reviewed for familiarization with safety markings and instructions before operation.

This product is a Safety Class I instrument (provided with a protective earth terminal).

BEFORE APPLYING POWER

Verify that the product is set to match the available line voltage and the correct fuse is installed.

SAFETY EARTH GROUND

An uninterruptible safety earth ground must be provided from the main power source to the product input wiring terminals, power cord, or supplied power cord set.

WARNINGS

Any interruption of the protective (grounding) conductor (inside or outside the instrument) or disconnecting the protective earth terminal will cause a potential shock hazard that could result in personal injury. (Grounding one conductor of a two conductor outlet is not sufficient protection.) In addition, verify that a common ground exists between the unit under test and this instrument prior to energizing either unit.

Whenever it is likely that the protection has been impaired, the instrument must be made inoperative and be secured against any unintended operation.

If this instrument is to be energized via an auto-transformer (for voltage reduction) make sure the common terminal is connected to neutral (that is, the grounded side of the mains supply).

Servicing instructions are for use by service-trained personnel only. To avoid dangerous electric shock, do not perform any servicing unless qualified to do so. Adjustments described in the manual are performed with power supplied to the instrument while protective covers

are removed. Energy available at many points may, if contacted, result in personal injury.

Capacitors inside the instrument may still be charged even if the instrument has been disconnected from its source of supply.

For continued protection against fire hazard, replace the line fuse(s) only with 250V fuse(s) of the same current rating and type (for example, normal blow, time delay, etc.) Do not use repaired fuses or short-circuited fuseholders.

SAFETY SYMBOLS



Instruction manual symbol: the product will be marked with this symbol when it is necessary for the user to refer to the instruction manual (see Table of Contents for page references).



Indicates hazardous voltages.



Indicates earth (ground) terminal.

WARNING

The WARNING sign denotes a hazard. It calls attention to a procedure, practice, or the like, which, if not correctly performed or adhered to, could result in personal injury. Do not proceed beyond a WARNING sign until the indicated conditions are fully understood and met.

CAUTION

The CAUTION sign denotes a hazard. It calls attention to an operating procedure, practice, or the like, which, if not correctly performed or adhered to, could result in damage to or destruction of part or all of the product. Do not proceed beyond a CAUTION sign until the indicated conditions are fully understood and met.

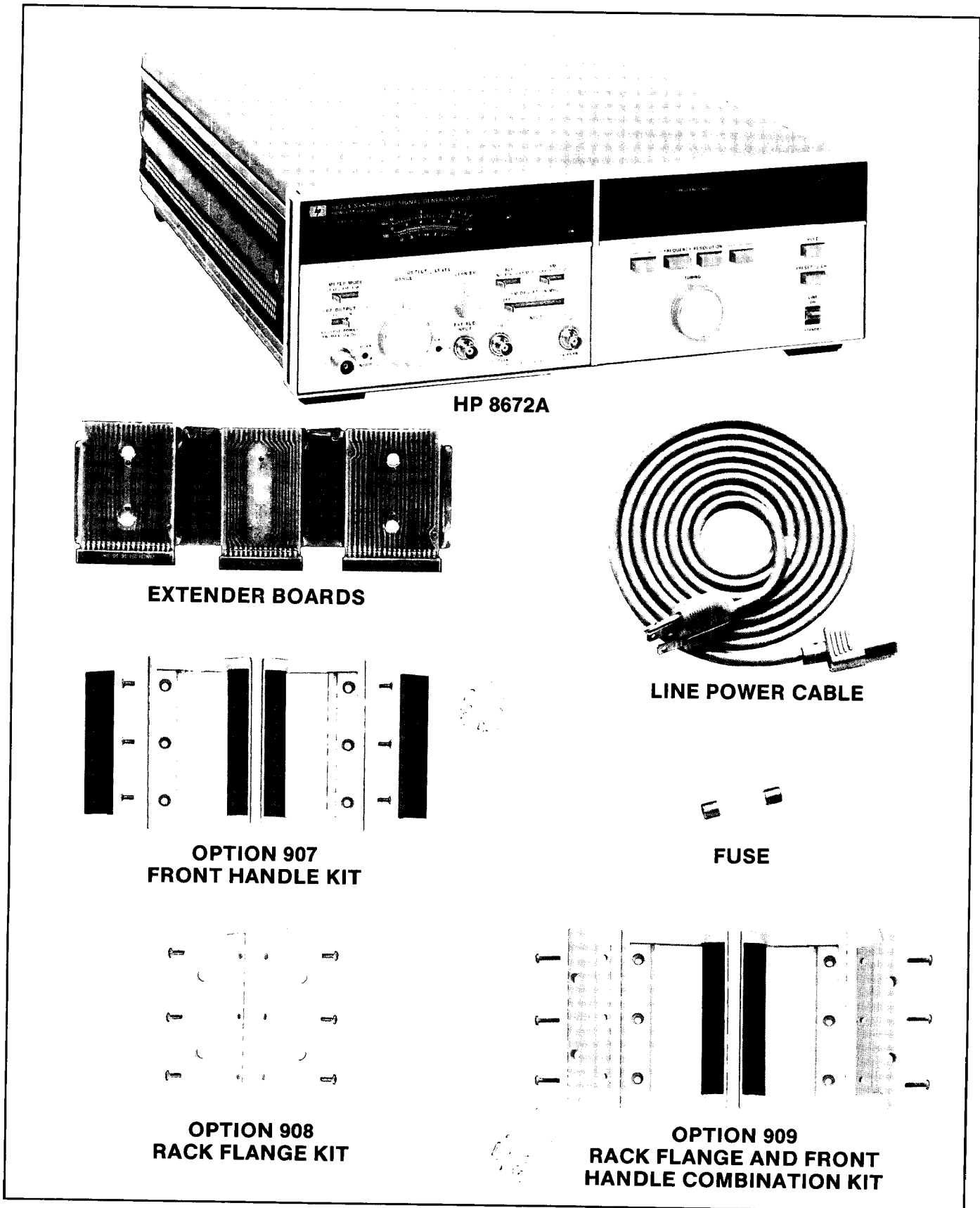

Figure 1-1. HP 8672A Accessories Supplied, and Options 907, 908, and 909

SECTION I GENERAL INFORMATION

1-1. INTRODUCTION

The HP 8672A operating and service information consists of an Operating Manual and a Service Manual. These two volumes contain all the information required to install, operate, test, adjust and service the HP 8672A Synthesized Signal Generator. Figure 1-1 shows an HP 8672A Signal Generator with all of its externally supplied accessories.

The Operating Manual, which is shipped with each instrument, has four sections:

- Section I, General Information
- Section II, Installation
- Section III, Operation
- Section IV, Performance Tests

The Service Manual, which is shipped with the instrument as Option 915 or ordered separately, has four sections:

- Section V, Adjustments
- Section VI, Replaceable Parts
- Section VII, Manual Changes
- Section VIII, Service

Additional copies of the Operating Manual or the Service Manual can be ordered separately through your nearest Hewlett-Packard office. The part number for each is listed on the title page of the manual.

Also listed on the title page of this manual, below the manual part number, is a microfiche part number. This number may be used to order 100 x 150 millimetre (4 x 6 inch) microfilm transparencies of this manual. Each microfiche contains up to 96 photo-duplicates of the manual pages. The microfiche package also includes the latest Manual Changes supplement, as well as all pertinent Service Notes.

1-2. SPECIFICATIONS

Instrument specifications are listed in Table 1-1. These specifications are the performance standards or limits against which the instrument may be tested. Supplemental characteristics are listed in Table 1-2. Supplemental characteristics are not

warranted specifications, but are typical characteristics included as additional information for the user.

1-3. SAFETY CONSIDERATIONS

This product is a Safety Class I instrument, that is, one provided with a protective earth terminal. The Signal Generator and all related documentation should be reviewed for familiarization with safety markings and instructions before operation. Refer to the Safety Considerations page found at the beginning of this manual for a summary of the safety information. Safety information for installation, operation, performance testing, adjustment, or service is found in appropriate places throughout this manual.

1-4. INSTRUMENTS COVERED BY THIS MANUAL

Attached to the rear panel of the instrument is a serial number plate. The serial number is in the form: 0000A00000. The first four digits and the letter are the serial number prefix. The last five digits are the suffix. The prefix is the same for identical instruments; it changes only when a configuration change is made to the instrument. The suffix however, is assigned sequentially and is different for each instrument. The contents of this manual apply directly to instruments having the serial number prefix(es) listed under SERIAL NUMBERS on the title page.

1-5. MANUAL CHANGES SUPPLEMENT

An instrument manufactured after the printing of this manual may have a serial number prefix that is not listed on the title page. This unlisted serial number prefix indicates that the instrument is different from those documented in this manual. The manual for this newer instrument is accompanied by a Manual Changes supplement. The supplement contains "change information" that explains how to adapt this manual to the newer instrument.

In addition to change information, the supplement may contain information for correcting errors in the manual. To keep the manual as current and as

MANUAL CHANGES SUPPLEMENT (cont'd)

accurate as possible, Hewlett-Packard recommends that you periodically request the latest Manual Changes supplement. The supplement is identified with the manual print date and part number, both of which appear on the manual title page. Complimentary copies of the supplement are available from Hewlett-Packard.

For information concerning a serial number prefix that is not listed on the title page or in the Manual Changes supplement, contact your nearest Hewlett-Packard office.

1-6. DESCRIPTION

The HP 8672A Synthesized Signal Generator has a frequency range of 2.0 to 18.0 GHz. The output is leveled and calibrated from +8 dBm to -120 dBm.¹ Frequency, output level, modulation, and ALC modes can be remotely programmed via HP-IB.

The frequency can be tuned with one of four frequency resolutions. Tuning resolutions of 100 MHz, 1 MHz, 10 kHz or 1 kHz are selected by front panel pushbuttons. The 1 kHz tuning resolution will give tuning resolutions of 1 kHz for frequencies from 2.0 to 6.2 GHz, 2 kHz for frequencies from 6.2 to 12.4 GHz, and 3 kHz for frequencies from 12.4 to 18.599997 GHz.

Long-term frequency stability is dependent on the time base, either an internal or external reference oscillator. The internal crystal reference oscillator operates at 10 MHz while an external oscillator may operate at 5 or 10 MHz.

The output of the Signal Generator is exceptionally flat due to the action of the internal automatic leveling control (ALC). External leveling control using a diode detector or a power meter to sense output power can be used to level the output at a remote load.

The output level is set using the OUTPUT LEVEL RANGE switch and the OUTPUT LEVEL VERNIER. The OUTPUT LEVEL RANGE switch changes the output level in 10 dB increments (+10 to -110 dB). The OUTPUT LEVEL VERNIER is then used to adjust the output level over a continuous 13 dB range (-10 to +3 dBm). The output level is read by adding the vernier setting to the range setting.

Both amplitude and frequency modulation capabilities are available in the Signal Generator using

either front panel switches or remote programming. External drive signals are required for both AM and FM operation. AM depth and FM deviation vary linearly with the applied external voltage. Full scale modulation is attained with 1.0V peak.

Two ranges of AM depth are selectable: 30% and 100%. The front panel meter can be used to monitor the AM depth. Allowable depths are: up to 75% between 2000 MHz and 6200 MHz, up to 60% between 6200 MHz and 12 400 MHz, and up to 50% between 12 400 and 18 000 MHz. Specified AM rates are from 10 Hz to 100 kHz.

Six ranges of FM deviation are selectable: 0.03, 0.1, 0.3, 1, 3, and 10 MHz. FM peak deviation can be monitored using the front panel meter. At output frequencies below 6200 MHz, peak deviation is limited to 10 MHz or five times the modulation frequency, whichever is lower. From 6200 to 12 400 MHz, peak deviation is limited to the lesser of 10 MHz or ten times the modulation frequency. From 12 400 MHz to 18 000 MHz, peak deviation is limited to the lesser of 10 MHz or fifteen times the modulation frequency. Allowable modulation rates fall between 50 Hz and 10 MHz.

The front panel meter indicates output level, AM depth, or FM peak deviation. Meter indication mode is selected by a front panel switch.

External leveling is selected by a front panel switch. A power meter or crystal detector may be used as the external detector.

Phase-locked reference outputs of 10 and 100 MHz are available on the rear panel.

Six status indicators on the front panel make operating the Signal Generator easier and aid in reducing possible operator error.

The Signal Generator is compatible with HP-IB to the extent indicated by the following codes: SH1, AH1, T6, TE0, L4, LE0, SR1, RL2, PP2, DC1, DT0, and C0. An explanation of the compatibility code can be found in IEEE Standard 488 (1978), "IEEE Standard Digital Interface for Programmable Instrumentation" or the identical ANSI Standard MC1.1. For more detailed information relating to programmable control of the Signal Generator, refer to Remote Operation, Hewlett-Packard Interface Bus in Section III of this manual.

1-7. Remote Operation 

The Signal Generator is fully programmable via the Hewlett-Packard Interface Bus. In the remote

¹For serial number prefixes of 2640A or below (except Option 008), maximum leveled and calibrated output power is +3 dBm.

Remote Operation **HP-IB** (cont'd)

mode all front panel controls are disabled except the LINE and METER MODE switches. Table 3-4 in Section III lists all HP-IB program codes. For more information refer to section 3-23, Remote (HP-IB) Operation.

1-8. Selecting the HP-IB Address

The HP-IB address switches are located within the Signal Generator. The switches represent a two-digit octal number. This number corresponds to talk and listen address characters which an HP-IB controller is capable of generating. Table 2-1 in Section II shows all HP-IB talk and listen addresses. For more information refer to section 2-7, HP-IB Address Selection.

1-9. OPTIONS

1-10. Electrical Options

Options 001 and 005. Both of these options omit the internal RF step attenuator and have only two positions on the OUTPUT LEVEL RANGE switch. Option 001's output level specification is +10 to -10 dBm. Option 005 has a rear panel RF OUTPUT connector; its output level specification is +9 to -10 dBm, and its total indicated level accuracy and flatness specifications are degraded by ± 0.25 dB.

Option 002. The internal 10 MHz crystal reference is omitted.

Option 003. A special fan allows operation from a 400 Hz power source (main).

Option 004. The Signal Generator's RF output connector is located on the rear panel. Maximum output power is +7 dBm. Total indicated level accuracy and flatness is degraded by ± 0.25 dB.

Option 008. For serial number prefixes 2640A and below, Option 008 provided +8 dBm leveled output power from 2.0 to 18.0 GHz. For serial number prefixes 2643A and above, these features have been incorporated into the standard Signal Generator.

Option 034 and 038. Both of these options omit the internal RF step attenuator and are used in conjunction with the HP 86720A Frequency Extension Unit to form an HP 8672S Signal Generator System. Option 034 provides control signals for a 110 dB step attenuator in the HP 86720A and has specified power between +10 and -120 dBm. Option 038 has specified power from +10 to -10 dBm with only two positions on the OUTPUT LEVEL

RANGE Switch. Both of these options have an additional connector on the rear panel for controlling the HP 86720A Frequency Extension Unit, and can display the entire frequency range of the HP 8672S system (10 MHz to 18 GHz).

1-11. Mechanical Options

The following options may have been ordered and received with the Signal Generator. If they were not ordered with the original shipment and are now desired, they can be ordered from the nearest Hewlett-Packard office using the part numbers included in each of the following paragraphs.

Option 006 (Chassis Slide Mount Kit). This kit is extremely useful when the Signal Generator is rack mounted. Access to internal circuits and components or the rear panel is possible without removing the Signal Generator from the rack. Order HP part number 1494-0059. When this kit comes with the Signal Generator, it is identified as Option 006. If the instrument rack mounting slides are to be mounted in a non-HP rack, then an adapter (HP part number 1494-0061) is needed. The slides without the adapter can be directly mounted in the HP system enclosures.

Option 907 (Front Handle Kit). Ease of handling is increased with the front panel handles. The Front Handle Kit part number is 5061-9689.

Option 908 (Rack Flange Kit). The Signal Generator can be solidly mounted to the instrument rack using the flange kit. The Rack Flange Kit part number is 5061-9677.

Option 909 (Rack Flange and Front Handle Combination Kit). This is a unique part which combines both functions. It is not simply a front handle kit and a rack flange kit packaged together. The Rack Flange and Front Panel Combination Kit part number is 5061-9683.

1-12. ACCESSORIES SUPPLIED

The accessories supplied with the Signal Generator are shown in Figure 1-1.

a. The line power cable is supplied in several configurations, depending on the destination of the original shipment. Refer to Power Cables in Section II of this manual.

b. An additional fuse is shipped only with instruments that are factory configured for 100/120 Vac operation. This fuse has a 1.5A rating and is for reconfiguring the instrument for 220/240 Vac operation.

ACCESSORIES SUPPLIED (cont'd)

c. Four extender boards are supplied for adjusting, and troubleshooting the instrument.

1. One 30-pin (15 x 2) extender board, HP part number 08672-60117.
2. Two 36-pin (18 x 2) extender boards, HP part number 08672-60020.
3. One 3-section, 30-pins (15 x 2) per section, extender board, HP part number 08672-60016 (for use in the A2 Assembly).

1-13. EQUIPMENT REQUIRED BUT NOT SUPPLIED

An external frequency reference is required for Option 002 Signal Generators. Either a 5 or 10 MHz oscillator may be used. The external reference should equal or exceed the following performance specifications:

Signal Power0 dBm (nominal)
Accuracy10 MHz \pm 200 Hz or 5 MHz \pm 100 Hz
Aging rate $<5 \times 10^{-10}$ /day after 24 hour warmup

When using an external oscillator, microphonically generated or line related spurious signals may increase. Single-sideband phase noise may also be degraded at some offsets from the carrier.

An external signal source is required if amplitude or frequency modulation is desired. For AM, the source should have a variable output of 0 to 1 Vpk

into 600 ohms, a frequency range of up to 100 kHz, and distortion of $<1\%$. For FM, the source should have a variable output of 0 to 1 Vpk into 50 ohms, a frequency range of up to 10 MHz, and distortion of $<1\%$. The HP 8116A Pulse/Function Generator will meet the above requirements for modulating the Signal Generator.

1-14. ELECTRICAL EQUIPMENT AVAILABLE

The Signal Generator has an HP-IB interface and can be used with any HP-IB compatible computing controller or computer for automatic systems applications.

The HP-IB Controller is needed for performance testing. Controllers that are supported by this manual include the HP 9826A, 9836A, and HP 85B/82937A.

The HP 11712A Support Kit is available for maintaining and servicing the Signal Generator. It includes a special test extender board, cables and adapters.

1-15. RECOMMENDED TEST EQUIPMENT

Table 1-3 lists the test equipment recommended for testing, adjusting and servicing the Signal Generator. Essential requirements for each piece of test equipment are described in the Critical Specifications column. Other equipment can be substituted if it meets or exceeds these critical specifications.

Table 1-1. Specifications (1 of 5)

Note: Specifications apply after 1-hour warm-up, over the temperature range 0 to 55°C (except specifications for RF output level which apply over the range 15 to 35° C). Specifications for output flatness, absolute level accuracy and modulation apply only when internal leveling is used.

Electrical Characteristics	Performance Limits	Conditions
<p>FREQUENCY</p> <p>Range</p> <p>Resolution</p> <p>Accuracy and Stability</p> <p>Switching Time Frequency (to be within the specified resolution -1 kHz in 2.0 to 6.2 GHz range, etc.)</p> <p>Amplitude (after switching frequency) to be within ±3 dB of final level</p> <p>Reference Oscillator Frequency</p> <p>Aging Rate</p>	<p>2.0–18.0 GHz (Overrange to 18.599997 GHz)</p> <p>1 kHz 2 kHz 3 kHz</p> <p>Same as reference oscillator</p> <p><20 ms¹</p> <p><15 ms</p> <p>10 MHz</p> <p><5 x 10⁻¹⁰/day</p>	<p>2.0 to 6.2 GHz 6.2 to 12.4 GHz 12.4 to 18.0 GHz</p> <p>When switching within the same frequency resolution band</p> <p>After a 10 day warmup (typically 24 hours in a normal operating environment)</p>
<p>SPECTRAL PURITY</p> <p>Single-sideband Phase Noise</p> <p>2.0–6.2 GHz</p> <p>6.2–12.4 GHz</p> <p>12.4–18.0 GHz</p> <p>Harmonics</p>	<p><-58 dBc <-70 dBc <-78 dBc <-86 dBc <-110 dBc</p> <p><-52 dBc <-64 dBc <-72 dBc <-80 dBc <-104 dBc</p> <p><-48 dBc <-60 dBc <-68 dBc <-76 dBc <-100 dBc</p> <p><-25 dBc</p>	<p>1 Hz bandwidth 10 Hz offset from carrier 100 Hz offset from carrier 1 kHz offset from carrier 10 kHz offset from carrier 100 kHz offset from carrier</p> <p>10 Hz offset from carrier 100 Hz offset from carrier 1 kHz offset from carrier 10 kHz offset from carrier 100 kHz offset from carrier</p> <p>10 Hz offset from carrier 100 Hz offset from carrier 1 kHz offset from carrier 10 kHz offset from carrier 100 kHz offset from carrier</p> <p>At +8 dBm</p>

Table 1-1. Specifications (2 of 5)

Electrical Characteristics	Performance Limits	Conditions
<p>SPECTRAL PURITY (cont'd)</p> <p>Subharmonics and multiples thereof</p> <p>Spurious Signals, non-harmonically related, except power line and fan rotation related</p> <p>Power line related and fan rotation related within 5 Hz below line frequencies and multiples thereof</p> <p>2.0—6.2 GHz</p> <p>6.2—12.4 GHz</p> <p>12.4—18.0 GHz</p>	<p><-25 dBc</p> <p><-70 dBc <-64 dBc <-60 dBc</p> <p><-50 dBc <-60 dBc <-65 dBc</p> <p><-44 dBc <-54 dBc <-59 dBc</p> <p><-40 dBc <-50 dBc <-55 dBc</p>	<p>2.0—6.2 GHz 6.2—12.4 GHz 12.4—18.0 GHz</p> <p><300 Hz offset from carrier 300 Hz to 1 kHz offset from carrier >1 kHz offset from carrier</p> <p><300 Hz offset from carrier 300 Hz to 1 kHz offset from carrier >1 kHz offset from carrier</p> <p><300 Hz offset from carrier 300 Hz to 1 kHz offset from carrier >1 kHz offset from carrier</p>
<p>RF OUTPUT</p> <p>Output Power</p> <p>Standard</p> <p>Option: 001</p> <p>004</p> <p>005</p> <p>Remote Programming Absolute Level Accuracy</p> <p>2.0—6.2 GHz</p> <p>6.2—12.4 GHz</p> <p>12.4—18.0 GHz</p>	<p>+8 dBm to -120 dBm² +10 dBm to -10 dBm +7 dBm to -120 dBm +9 dBm to -10 dBm</p> <p>±1.00 dB³ ±1.00 dB ±1.50 dB ±1.70 dB ±1.90 dB ±1.90 dB & ±0.3 dB per 10 dB step</p> <p>±1.25 dB³ ±1.25 dB ±1.75 dB ±1.95 dB ±2.15 dB ±2.15 dB & ±0.3 dB per 10 dB step</p> <p>±1.50 dB³ ±1.50 dB ±2.10 dB</p>	<p>+15 to +35°C +15 to +35°C +15 to +35°C +15 to +35°C</p> <p>+10 dB output level range³ 0 dB output level range -10 dB output level range -20 dB output level range -30 dB output level range <-30 dB output level range</p> <p>+10 dB output level range³ 0 dB output level range -10 dB output level range -20 dB output level range -30 dB output level range <-30 dB output level range</p> <p>+10 dB output level range³ 0 dB output level range -10 dB output level range</p>

Table 1-1. Specifications (3 of 5)

Electrical Characteristics	Performance Limits	Conditions
<p>RF OUTPUT (cont'd) 12.4—18.0 GHz (cont'd)</p> <p>Manual Absolute Level Accuracy</p> <p>Remote Programming Output Level Resolution</p> <p>Flatness (total variation) Standard</p> <p>Option 001, 005</p> <p>Output Leveling Switching Time (to be within ± 1 dB of final level)</p>	<p>± 2.30 dB ± 2.40 dB ^{2.70} ± 2.40 dB & ± 0.4 dB per 10 dB step ^{2.70} Add ± 0.75 dB to remote programming absolute level accuracy</p> <p>1 dB</p> <p>1.50 dB 2.00 dB 2.50 dB Add 0.80 dB</p> <p><20 ms</p>	<p>-20 dB output level range -30 dB output level range <-30 dB output level range</p> <p>Absolute level accuracy specifications include allowances for detector linearity, temperature, flatness, attenuator accuracy, and measurement uncertainty.</p> <p>+10 dB Range, +15°C to +35°C³</p> <p>2.0 to 6.2 GHz 2.0 to 12.4 GHz 2.0 to 18.0 GHz</p>
<p>AMPLITUDE MODULATION Depth⁴</p> <p>2.0—6.2 GHz 6.2—12.4 GHz 12.4—18.0 GHz</p> <p>Bandwidth</p> <p>Frequency Response</p> <p>Sensitivity (percent AM per Vpk) 30% Range 100% Range</p> <p>Distortion AM Depth 30% 50% 75%</p> <p>Indicated Meter Accuracy</p> <p>Accuracy Relative to External AM Input Level</p> <p>Incidental FM</p>	<p>0—75% 0—60% 0—50%</p> <p>10 Hz—100 kHz</p> <p>± 0.25 dB</p> <p>30%/Vpk 100%/Vpk</p> <p><3% <4% <5%</p> <p>$\pm 5\%$ of range $\pm 10\%$ of range</p> <p>Incidental Phase Modulation \times Modulation Frequency</p>	<p>For vernier meter readings less than or equal to 0 dBm and power level settings less than or equal to 0 dBm. +15°C to +35°C</p> <p>100 Hz—10 kHz</p> <p>Maximum input 1 Vpk into 600 ohms nominal⁵</p> <p>For rates less than or equal to 10 kHz and vernier meter readings less than or equal to 0 dBm and power level settings less than or equal to 0 dBm, +15°C to +35°C</p> <p>100 Hz—10 kHz rates 100 Hz—10 kHz rates</p>

Table 1-1. Specifications (4 of 5)

Electrical Characteristics	Performance Limits	Conditions
<p>FREQUENCY MODULATION Maximum Peak Deviation 2.0—6.2 GHz 6.2—12.4 GHz 12.4—18.0 GHz Bandwidth Frequency Response (relative to 100 kHz rate) Sensitivity (peak deviation per Vpk) All Ranges Harmonic and Nonharmonic Distortion⁷ Residual FM (noise and power line related)⁸ Model/Range CW 30, 100 kHz/V 0.3, 1, 3, and 10 MHz/V Indicated Meter Accuracy (at 100 kHz rate)⁹ Accuracy Relative to External FM Input Level (at 100 kHz rate)⁹ Incidental AM</p>	<p>The smaller of: 10 MHz or $f_{\text{mod}} \times 5$ 10 MHz or $f_{\text{mod}} \times 10$ 10 MHz or $f_{\text{mod}} \times 15$ 50 Hz to 10 MHz 1 kHz to 10 MHz ± 2.0 dB, 100 kHz—3 MHz ± 2.0 dB, 3 kHz—3 MHz 1 Vpk = range maximum deviation⁶ $< 12\%$ $< 12\%$ decreasing linearly with frequency to 5% $< 5\%$ 16 Hz rms 80 Hz rms 20 Hz rms 100 Hz rms $\pm 10\%$ of full scale $\pm 15\%$ of full scale $\pm 7\%$ of range $\pm 10\%$ of range $< 10\%$</p>	<p>30 and 100 kHz/V ranges 0.3, 1, 3, and 10 MHz/V ranges 30 and 100 kHz/V ranges 0.3, 1, 3, and 10 MHz/V ranges All ranges. Maximum Input 1 Vpk into 50Ω nominal. Rates < 3 kHz Rates 3 kHz—20 kHz Rates 20—100 kHz Post Detection Bandwidth: 300—3 kHz 50 Hz—15 kHz 300—3 kHz 50 Hz—15 kHz +15°C to +35°C 0 to +55°C +15°C to +35°C 0 to +55°C Rates ≤ 100 kHz, peak deviation ≤ 1 MHz</p>
<p>REMOTE OPERATION Frequency Output Level RF Output ALC AM Modulation FM Modulation Interface Function Codes</p>	<p>Programmable over full range with same resolution as manual mode. Programmable in 1 dB steps, +8 to -120 dBm, plus 5 dB of overrange¹⁰ Programmable to either ON or OFF. Programmable for internal, crystal diode, or power meter leveling. Programmable for OFF, 30%/Vpk, and 100%/Vpk ranges. Programmable for OFF; 30, 100, 300 kHz/Vpk; 1, 3, 10 MHz/Vpk ranges. SH1, AH1, T6, TE0, L4, LE0, SR1, RL2, PP2, DC1, DT0, and C0.</p>	
<p>GENERAL Operating Temperature Power EMI</p>	<p>0 to +55°C (see note at the beginning of this table). 100, 120, 220, or 240V, +5%, -10%, 48—66 Hz, 300 VA maximum. Conducted and radiated interference is within the requirements of MIL-I-6181D.</p>	

Table 1-1. Specifications (5 of 5)

GENERAL (cont'd)	
Net Weight	27.2 kg (60 lbs)
Dimensions: Height	146 mm (5.7 in.) (includes instrument feet)
Width	425 mm (16.8 in.)
Depth	620 mm (24.4 in.) (includes rear panel standoffs)
	For ordering cabinet accessories, module sizes are 5¼H, 1 MW, 23D, System II
Accessories	Power Cord, Operating and Service Manual, and four extender boards.
<p>¹ For serial number prefixes of 2649A and below, change "<20 ms" to "<15 ms". <i>PCO 04-09341</i></p> <p>² For serial number prefixes of 2640A and below (except Option 008), Level specification is +3 to -120 dBm.</p> <p>³ For serial number prefixes of 2640A and below (except Option 008), there is no +10 dB output level range.</p> <p>⁴ The meter reading of output power level when using AM does NOT include power in AM sidebands.</p> <p>⁵ 1.0 Vpk gives maximum depth on each range. AM depth is linearly controlled by varying input level between 0 and 1 Vpk.</p> <p>⁶ 1.0 Vpk gives maximum deviation on each range. Peak deviation is linearly controlled by varying input level between 0 and 1 Vpk.</p> <p>⁷ For certain FM modulating frequencies, spurious FM signals (nonharmonic distortion) may occur. After demodulation in an external FM discriminator, the contribution to distortion of these spurious FM signals is typically less than 0.6%.</p> <p>⁸ Residual FM doubles in 6.2-12.4 GHz range; triples in 12.4-18.0 GHz range.</p> <p>⁹ For FM rates other than 100 kHz, add FM frequency response specification.</p> <p>¹⁰ For serial number prefixes of 2640A and below (except Option 008), the specification is "Programmable in 1 dB steps, +3 to -120 dBm, plus the 10 dB of overrange".</p>	

Table 1-2. Supplemental Characteristics

<p>Supplemental characteristics are intended to provide information useful in applying the instrument by giving typical, but non-warranted, performance parameters.</p>	
<p style="text-align: center;">FREQUENCY</p> <p>Internal Reference: The internal reference oscillator accuracy is a function of time base calibration ± aging rate, ± temperature effects, and ± line voltage effects. Typical temperature and line voltage effects are $<1 \times 10^{-7}/^{\circ}\text{C}$ and $<5 \times 10^{-10}/+5\%$ to -10% line voltage change. Reference oscillator is kept at operating temperature in STANDBY mode with the instrument connected to mains power. The aging rate is $<5 \times 10^{-10}/\text{day}$ after a 24 hour warmup.</p> <p>External Reference Input: 5 or 10 MHz at a level of 0.1 to 1 Vrms into 50Ω. Stability and spectral purity of the microwave output will be partially determined by characteristics of the external reference frequency.</p> <p>Reference Outputs: 10 MHz at a level of 0.2 Vrms into 50Ω. 100 MHz at a level of 0.2 Vrms into 50Ω.</p>	<p style="text-align: center;">RF OUTPUT</p> <p>For power settings $>+3$ dBm, changes in frequency from <10 GHz to >16 GHz may require a settling period for the power to stabilize at the set level. Spurious output oscillations may occur for settings above +8 dBm.</p> <p>External leveling device characteristics will determine output flatness, absolute level accuracy, and switching time in external leveling modes.</p> <p>Maximum Reverse Power: 1W RF input; 1 MHz-20 GHz, 0 Vdc.</p> <p>Impedance: 50Ω.</p> <p>Source SWR: typically $\leq 2.5:1$.</p>
<p style="text-align: center;">SPECTRAL PURITY</p> <p>Residual FM: 80 Hz rms in a 50 Hz-15 kHz Post-detection bandwidth from 2-6.2 GHz. Residual FM doubles in the 6.2-12.4 GHz range and triples in the 12.4-18.0 GHz range.</p>	

Table 1-3. Recommended Test Equipment (1 of 3)

Instrument	Critical Specifications	Recommended Model	Use*
AC Voltmeter	Range: 1 mV to 10V Accuracy: $\pm 1.5\%$ of full scale $\pm 1.5\%$ of reading Frequency Response: 3 kHz to 3 MHz	HP 400E	A
Attenuator, Fixed 3 dB	Range: dc to 1 GHz Accuracy: ± 0.5 dB SWR: < 1.3	HP 8491A Option 003	A
Attenuator, Fixed 20 dB	Range: dc to 18 GHz Accuracy: ± 1.0 dB SWR: < 1.6	HP 8491B Option 020	C, P
Audio Analyzer	Frequency Range: 20 Hz to 100 kHz Accuracy: $\pm 4\%$ of full scale	HP 8903A/B	P
Cable, Special Interconnect	See YTO Loop Phase Detector Adjustments in Section V	Locally Fabricated	A
Controller, HP-IB	HP-IB compatibility as defined by IEEE Standard 488-1978 and the identical ANSI Standard MC1.1: SH1, AH1, T2, TE0, L2, LE0, SR0, RL0, PP0, DC0, DT0, and C1, 2, 3, 4, 5.	HP 85B/82937A or 9826A Option 011 or 9836A with BASIC 2.0 Operating System	C, A, T, P
Crystal Detector	Frequency Range: 2 to 18 GHz Frequency Response: ± 1.5 dB	HP 8470B Option 012	P, A
Current Probe	Frequency Range: 2 to 35 MHz	HP 1110B	A
Digital Voltmeter (DVM)	Range: -60 V to $+40$ V dc Resolution: 100μ V on 1V dc range	HP 3456A or HP 3455A	A, T
Foam Pads (2 required)	43×58 cm (17×23 in.), 5 cm (2 in.) thick		P
Frequency Counter	Range: 2 to 18 GHz Resolution: 1 kHz 10 MHz Frequency Standard Output: ≥ 0.1 Vrms	HP 5340A or HP 5343A	P, A, T
Frequency Standard	Long Term Stability: Better than 10^{-10} /day	HP 5065A	P, A
High Impedance Probe	Frequency: 400 MHz Output Impedance: 50Ω (compatible with Spectrum Analyzer).	HP 1121A	T
Local Oscillator	Range: 2 to 18 GHz Level: $+7$ dBm Single Sideband Phase Noise and Spurious Signals: Same as HP 8340A	HP 8340A	P, A
Logic State Analyzer	8 Bit Display, Triggerable	HP 1630A	T

Table 1-3. Recommended Test Equipment (2 of 3)

Instrument	Critical Specifications	Recommended Model	Use*
Logic Pulser	TTL compatible	HP 546A	T
Measuring Receiver or Modulation Analyzer	<p>Frequency Range: 150 to 990 MHz</p> <p>Input Level: -20 to +13 dBm</p> <p>Amplitude Modulation:</p> <p>Rates - 25 Hz to 25 kHz</p> <p>Depth - to 99%</p> <p>Accuracy - $\pm 2\%$ at 1 kHz</p> <p>Flatness - $\pm 0.5\%$</p> <p>Demodulated Output Distortion: - $< 0.3\%$ for 50% depth; $< 0.6\%$ for 90% depth</p> <p>Incidental Phase Modulation - < 0.05 radians for 50% depth at 1 kHz rate (50 Hz to 3 kHz bandwidth)</p> <p>Frequency Modulation:</p> <p>Rates - 25 Hz to 25 kHz</p> <p>Deviation - to 99 kHz</p> <p>Accuracy - $\pm 2\%$ at 1 kHz</p>	HP 8902A	P, A
Mixer	<p>Response: 2 to 18 GHz</p> <p>VSWR, LO: $\leq 2.5:1$</p> <p>VSWR, RF: $\leq 4.0:1$</p>	RHG DM 51 -18 ¹	P, A
Oscilloscope	<p>Bandwidth: 50 MHz</p> <p>Vertical Sensitivity: 50 mV/div</p> <p>Vertical Input: 50Ω ac or dc coupled</p> <p>External Trigger Capability</p>	HP 1980B	P, A, T
Power Meter	<p>Frequency: 2 to 18 GHz</p> <p>Range: +17 to -25 dBm</p>	HP 436A	P, A, T
Power Sensor	<p>Frequency: 2 to 18 GHz</p> <p>Input Impedance: 50Ω</p> <p>SWR: < 1.28</p> <p>Range: +17 to -25 dBm</p> <p>Must be compatible with power meter</p>	HP 8481A	P, A, T
Power Source, Variable Frequency AC	<p>Range: 110 to 120 Vac</p> <p>Frequency: 52 to 58 Hz</p> <p>Accuracy ± 2 Hz</p>	California Instruments 501TC/800T ²	P
Power Supply	0 to 40 Vdc	HP 6200B	A, T
Amplifier, 20 dB	<p>Frequency: 100 kHz</p> <p>Gain: 20 ± 5 dB</p> <p>Output Power: > -10 dBm</p> <p>Noise Figure: < 5 dBm</p> <p>Impedance: 50Ω</p>	HP 8447A	P

Table 1-3. Recommended Test Equipment (3 of 3)

Instrument	Critical Specifications	Recommended Model	Use*
Amplifier, 40 dB	Frequency: 100 kHz Gain: 45 ± 5 dB Output Power: > -10 dBm Impedance: 50Ω	HP 8447D and HP 8447E or HP 8447F	P
Probe, 10:1	Must be compatible with the oscilloscope.	HP 10017A	A
Signal Generator	Output Level: -5 to -20 dBm at 240 MHz	HP 8640B or HP 8340A	A
Spectrum Analyzer (with Tracking Generator)	Frequency Range: 20 Hz to 300 kHz Frequency Span/Division: 20 Hz minimum Noise Sidebands: > 90 dB below CW signal, 3 kHz offset, 100 Hz IF bandwidth Input Level Range: -10 to -60 dBm Log Reference Control: 70 dB dynamic range in 10 dB steps Accuracy: ± 0.2 dB	HP 8556A/8552B/141T	A
Spectrum Analyzer	Frequency Range: 5 Hz to 50 kHz Resolution Bandwidth: 1 Hz minimum Frequency Span/Division: 5 Hz to 500 Hz Amplitude Range: 0 to -70 dBm	HP 3580A	P, T
Spectrum Analyzer	Frequency Range: 100 kHz to 22 GHz Frequency Span/Division: 2 kHz minimum Amplitude Range: $+10$ to -90 dBm Noise Sideband: > 75 dB down 30 kHz from signal at 1 kHz resolution bandwidth Resolution Bandwidth: 30 Hz to 300 kHz	HP 8566B	P, A
Sweep Oscillator	Center Frequency: 150 to 200 MHz Center Frequency Resolution: 0.1 MHz Sweep Range: 10 and 200 MHz	HP 86222B/8620C or HP 8340A	A
Termination	50Ω BNC	HP 11593A	A
Termination	600Ω BNC Feedthrough	HP 11095A	P, A
Test Coupler Adapter	See YTM Adjustments in Section V	Locally fabricated	A
Test Oscillator	Level: 0 to 3V into 50Ω or 300Ω Range: 60 Hz to 10 kHz	HP 8116A	A, T

* C = Operator's Check, P = Performance Tests, A = Adjustments, T = Troubleshooting

¹ RHG Electronics Laboratory, Inc., 161 East Industry Court, Deer Park, NY 11729, Tel. (516) 242-1100, TWX 510-227-6083.

² California Instruments, 5150 Convoy Street, San Diego, CA 92111, Tel. (714) 279-8620.

SECTION II INSTALLATION

2-1. INTRODUCTION

This section provides the information needed to install the Signal Generator. Included is information pertinent to initial inspection, power requirements, line voltage selection, power cables, interconnection, environment, instrument mounting, storage and shipment.

2-2. INITIAL INSPECTION

WARNING

To avoid hazardous electrical shock, do not perform electrical tests when there are signs of shipping damage to any portion of the outer enclosure (covers, panels, meters).

Inspect the shipping container for damage. If the shipping container or cushioning material is damaged, it should be kept until the contents of the shipment have been checked for completeness and the instrument has been checked mechanically and electrically. The contents of the shipment should be as shown in Figure 1-1. Procedures for checking electrical performance are given in Section IV. If the contents are incomplete, if there is mechanical damage or defect, or if the instrument does not pass the electrical performance test, notify the nearest Hewlett-Packard office. If the shipping container is damaged or the cushioning material shows signs of stress, notify the carrier as well as the Hewlett-Packard office. Keep the shipping materials for the carrier's inspection.

2-3. PREPARATION FOR USE

2-4. Power Requirements

The Signal Generator requires a power source of 100, 120, 220 or 240 Vac, +5% to -10%, 48 to 66 Hz single phase. Power consumption is 300 VA maximum.

WARNING

This is a Safety Class I product (that is, provided with a protective earth terminal). An uninterruptible safety earth ground must be provided from the main

power source to the product input wiring terminals, power cord or supplied power cord set. Whenever it is likely that the protection has been impaired, the product must be made inoperative and be secured against any unintended operation.

If this instrument is to be energized via an external autotransformer, make sure the autotransformer's common terminal is connected to the neutral (that is, the grounded side of the mains supply).

2-5. Line Voltage and Fuse Selection

CAUTION

BEFORE PLUGGING THIS INSTRUMENT into the mains (line) voltage, be sure the correct voltage and fuses have been selected.

Verify that the line voltage selection cards and the fuses are matched to the power source. Refer to Figure 2-1, Line Voltage and Fuse Selection.

Fuses may be ordered under HP part numbers 2110-0003, 3.0A (250V) for 100/120 Vac operation and 2110-0043, 1.5A (250V) for 220/240 Vac operation.

2-6. Power Cables

WARNING

BEFORE CONNECTING THIS INSTRUMENT, the protective earth terminal of this instrument must be connected to the protective conductor of the (mains) power cables. The mains plug shall only be inserted in socket outlets provided with a protective earth contact. The protective action must not be negated by the use of an extension cord (power cable) without a protective conductor (grounding).

This instrument is equipped with a three-wire power cable. When connected to an appropriate ac power receptacle, this cable grounds the instrument

Operating voltage is shown in module window.

SELECTION OF OPERATING VOLTAGE

1. Open cover door, pull the FUSE PULL lever and rotate to left. Remove the fuse.
2. Remove the Line Voltage Selection Card. Position the card so the line voltage appears at top-left corner. Push the card firmly into the slot.
3. Rotate the FUSE PULL lever to its normal position. Insert a fuse of the correct value in the holder. Close the cover door.

WARNING

To avoid the possibility of hazardous electrical shock, do not operate this instrument at line voltages greater than 126.5 Vac with line frequencies greater than 66 Hz (leakage currents at these line settings may exceed 3.5 mA).

Figure 2-1. Line Voltage and Fuse Selection

Power Cables (cont'd)

cabinet. The power cable plug shipped with each instrument depends on the country of destination. Refer to Figure 2-2 for the part numbers of power cables available.

2-7. Address Selection

In the Signal Generator, the HP-IB talk and listen addresses and the parallel poll sense and response line can be selected by internal switches. Refer to Table 2-1 for a listing of talk and listen addresses. The address is factory set for a Talk address of "S" and a Listen address of "3". (In octal this is 23; in decimal this is 19.)

To change the HP-IB address or to select a different parallel poll response, proceed as follows:

WARNING

Internal switch settings should be changed only by service trained persons who are aware of the potential shock hazard of working on an instrument with protective covers removed.

To avoid hazardous electrical shock, the line (mains) power cable should be disconnected before attempting to change any internal switch settings.

<p>220/240V OPERATION</p> <p>PLUG*: SEV 1011.1959-24507 TYPE 12 CABLE*: HP 8120-2104</p>	<p>220/240V OPERATION</p> <p>PLUG*: NZSS 198/AS C112 CABLE*: HP 8120-1369</p>	<p>100/120V OPERATION</p> <p>PLUG*: NEMA 5-15P CABLE*: 8120-1378</p>	<p>220/240V OPERATION</p> <p>PLUG*: NEMA 6-15P CABLE*: HP 8120-0698</p>
<p>220/240V OPERATION</p> <p>PLUG*: CEE7-VII CABLE*: HP 8120-1689</p>	<p>220/240V OPERATION</p> <p>PLUG*: DHCK 107 CABLE*: HP 8120-2956</p>	<p>220/240V OPERATION</p> <p>PLUG*: BS 1363A CABLE: HP 8120-1351</p>	

*The number shown for the plug is the industry identifier for the plug only.
The number shown for the cable is an HP part number for a complete cable including the plug.

Figure 2-2. Power Cable and Mains Plug Part Numbers

Table 2-1. Allowable HP-IB Address Codes

Address Switches (Octal)		Talk Address Character	Listen Address Character	Decimal Equivalent
S1	S2			
0	0	@	SP	0
0	1	A	!	1
0	2	B	"	2
0	3	C	#	3
0	4	D	\$	4
0	5	E	%	5
0	6	F	&	6
0	7	G	'	7
1	0	H	(8
1	1	I)	9
1	2	J	*	10
1	3	K	+	11
1	4	L	,	12
1	5	M	-	13
1	6	N	.	14
1	7	O	/	15
2	0	P	0	16
2	1	Q	1	17
2	2	R	2	18
2	3	S	3	19
2	4	T	4	20
2	5	U	5	21
2	6	V	6	22
2	7	W	7	23
3	0	X	8	24
3	1	Y	9	25
3	2	Z	:	26
3	3	[;	27
3	4	\	<	28
3	5]	=	29
3	6	^	>	30

2-7. Address Selection **HP-IB** (cont'd)

- a. Set the LINE switch to STANDBY. Disconnect the line power cable.
- b. Remove the Signal Generator's top cover by removing the two plastic standoffs from the rear of the top cover and loosening the screw at the middle of the rear edge of the top cover. Then remove the A2 Assembly's protective cover. Refer to the Disassembly Procedures in Section VIII, Service Sheet A.
- c. Select the new address as shown in Table 2-1. The switches are shown in Figure 2-3. The HP-IB ADDRESS SELECT switch settings (for S1 and S2) are in the octal code. For example, the factory selected addresses are set to 23 (decimal 19). Therefore, the listen address is '3' and the talk address is 'S'.

d. If the parallel poll sense or response switches are to be changed, remove any HP-IB cables or connectors from the HP-IB connector, and remove the HP-IB connector. Then remove the A2A9 Board Assembly.

e. The PARALLEL POLL SENSE switch (S4) is set to either the OFF, 0 (zero) or 1 (one) position. The zero position provides a false (+2.5 to 5 volts) output on the asserted HP-IB data line; the one position provides a true (0 to +0.4V) output on the asserted HP-IB data line.

f. The PPR (Parallel Poll Response) switch (S3) is set to select one of eight lines (one of 1 through 8 of the HP-IB data bus). The selected line passes the Signal Generator's parallel poll response to the HP-IB controller.

g. Re-install the A2A9 Assembly and HP-IB connector.

h. Replace the A2 Assembly's internal cover, the instrument's top cover, and rear standoffs.

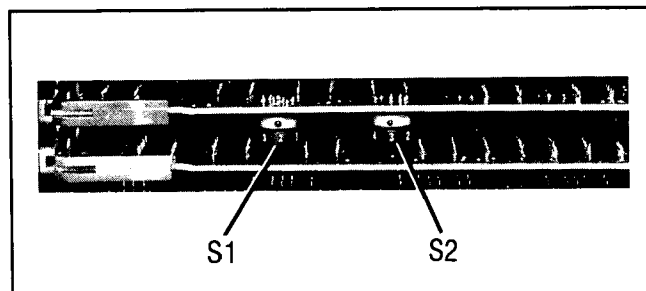

Figure 2-3. HP-IB Address Switches Shown as Set by the Factory

2-8. Interconnections

Interconnection data for the Hewlett-Packard Interface Bus is provided in Figure 2-4.

2-9. Mating Connectors

HP-IB Interface Connector. The HP-IB mating connector is shown in Figure 2-4. Note that the two securing screws are metric.

Coaxial Connectors. Coaxial mating connectors used with the Signal Generator RF output should be 50Ω Type N male connectors.

2-10. Operating Environment

The operating environment should be within the following limitations:

Operating Environment (cont'd)

Temperature	0 to +55°C
Humidity	<95% relative
Altitude	<4570 metres (15,000 feet)

NOTE

Specifications for RF Output apply only between +15 and +35°C.

2-11. Bench Operation

The instrument cabinet has plastic feet and fold-away tilt stands for convenience in bench operation. (The plastic feet are shaped to ensure self-aligning of the instruments when stacked.) The tilt stands raise the front of the instrument for easier viewing of the front panel.

2-12. Rack Mounting**WARNING**

The Signal Generator weighs 27.2 kg (60 lbs), therefore extreme care must be exercised when lifting to avoid personal injury. Use equipment slides when rack mounting the instrument.

Rack mounting information is provided with the rack mounting kits. If the kits were not ordered with the instrument as options, they may be ordered through the nearest Hewlett-Packard office. Refer to the paragraph entitled Mechanical Options in Section I.

2-13. STORAGE AND SHIPMENT**2-14. Environment**

The instrument should be stored in a clean, dry environment. The following environmental limitations apply to both storage and shipment:

Temperature	-55 to +75°C
Humidity	<95% relative
Altitude	15,300 metres (50,000 feet)

2-15. Packaging

Preparation for Packaging. Remove handles and/or rack mount flanges before packaging instrument for shipping.

Tagging for Service. If the instrument is being returned to Hewlett-Packard for service, please complete one of the blue repair tags located at the back of this manual and attach it to the instrument.

Original Packaging. Containers and materials identical to those used in factory packaging are available through Hewlett-Packard offices. Mark the container "FRAGILE" to assure careful handling. In any correspondence refer to the instrument by model number and full serial number.

Other Packaging. The following general instructions should be used for re-packaging with commercially available materials:

a. Wrap the instrument in heavy paper or plastic. (If shipping to a Hewlett-Packard office or service center, complete one of the blue tags mentioned above and attach it to the instrument.)

b. Use a strong shipping container. A double-wall carton made of 2.4 MPa (350 psi) test material is adequate.

c. Use enough shock-absorbing material (75 to 100 mm layer; 3 to 4 inches) around all sides of the instrument to provide firm cushion and prevent movement in the container. Protect the front panel with cardboard.

d. Seal the shipping container securely.

e. Mark the shipping container "FRAGILE" to assure careful handling.

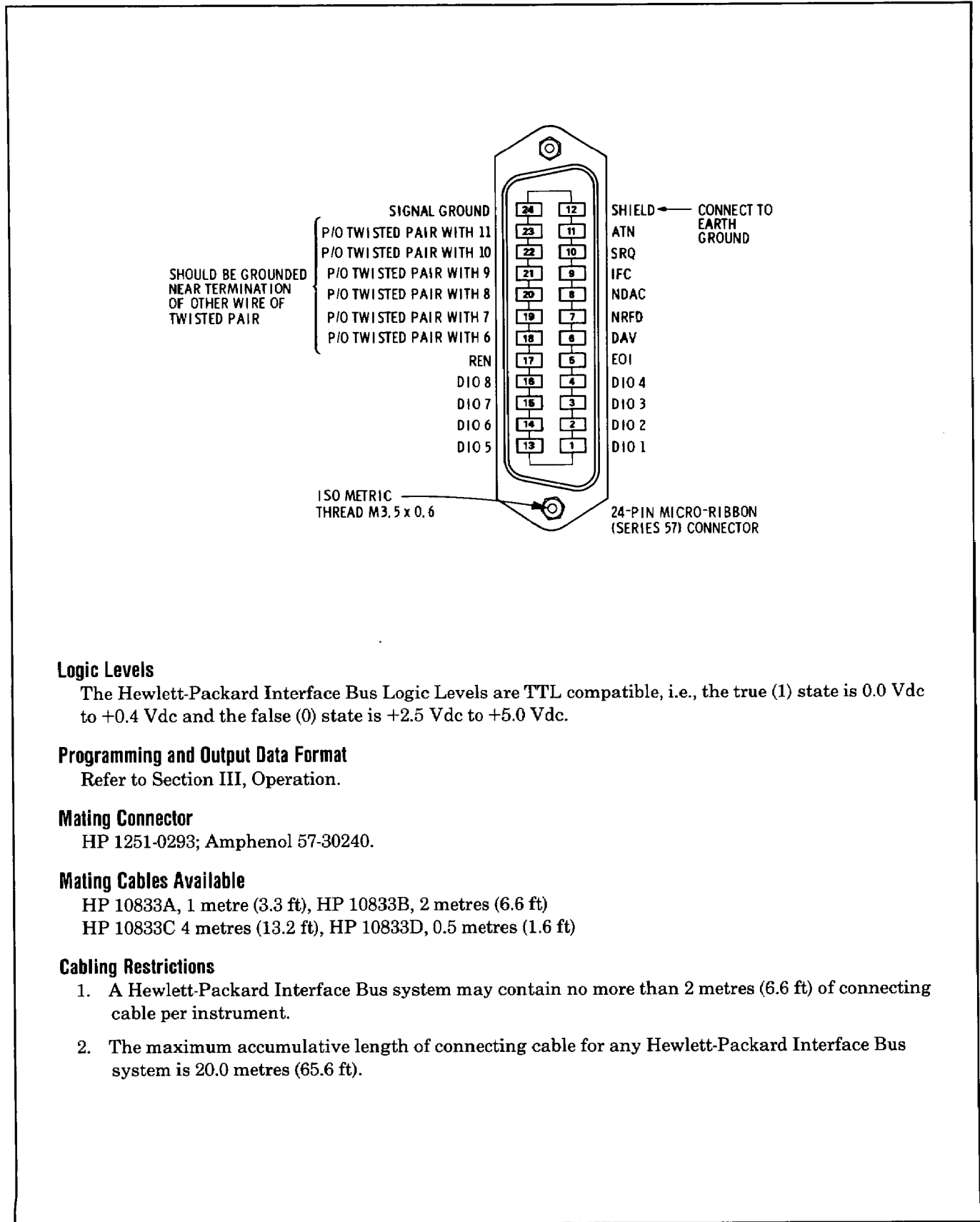

Logic Levels

The Hewlett-Packard Interface Bus Logic Levels are TTL compatible, i.e., the true (1) state is 0.0 Vdc to +0.4 Vdc and the false (0) state is +2.5 Vdc to +5.0 Vdc.

Programming and Output Data Format

Refer to Section III, Operation.

Mating Connector

HP 1251-0293; Amphenol 57-30240.

Mating Cables Available

HP 10833A, 1 metre (3.3 ft), HP 10833B, 2 metres (6.6 ft)
HP 10833C 4 metres (13.2 ft), HP 10833D, 0.5 metres (1.6 ft)

Cabling Restrictions

1. A Hewlett-Packard Interface Bus system may contain no more than 2 metres (6.6 ft) of connecting cable per instrument.
2. The maximum accumulative length of connecting cable for any Hewlett-Packard Interface Bus system is 20.0 metres (65.6 ft).

Figure 2-4. Hewlett-Packard Interface Bus Connections

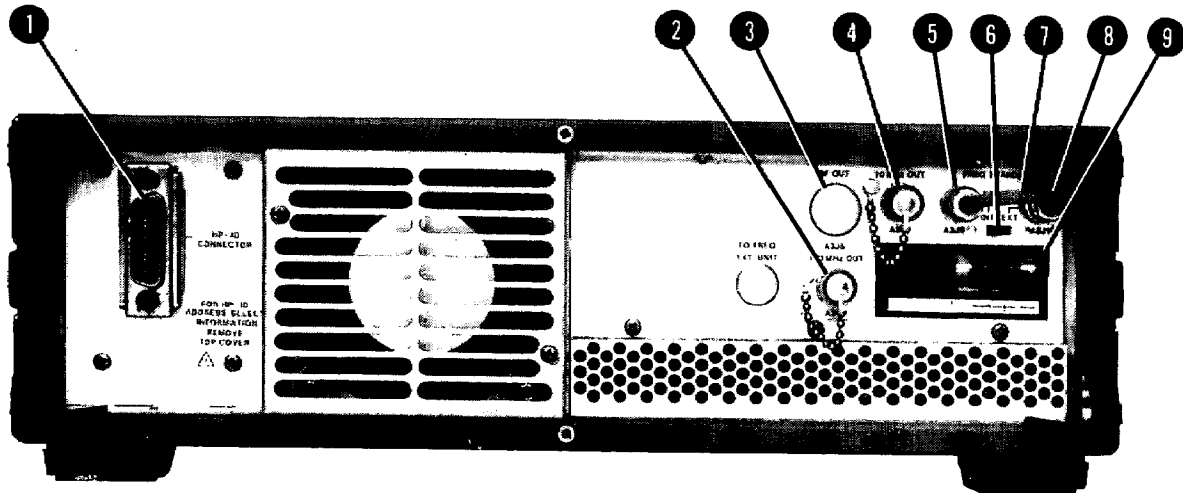

- 1 **HP-IB CONNECTOR:** connects the Signal Generator to the Hewlett-Packard Interface Bus for remote operation. When in remote operation, the REMOTE annunciator illuminates.
- 2 **100 MHz OUT (A3J7):** 0 dBm (nominal) into 50 ohms, can be used as an external timebase and for troubleshooting.
- 3 **RF OUT (A3J6):** only for Options 004 and 005, 50 ohm type N output connector (see Table 1-1 for Option information).
- 4 **10 MHz OUT (A3J8):** 0 dBm (nominal) into 50 ohms, can be used as an external timebase and for troubleshooting.
- 5 **FREQ STANDARD Output (A3J9):** 10.000 MHz into 50 ohms at +7 dBm (nominal) from the internal reference oscillator except when INT/EXT switch 6 is in the EXT position.
- 6 **FREQ STANDARD INT/EXT switch:** normally set to the INT position. Removes power from internal reference oscillator when in the EXT position.
- 7 **Jumper (A3W3):** normally connects the Internal Frequency Standard Output (A3J9) to the External Frequency Standard Input (A3J10).
- 8 **FREQ STANDARD Input (A3J10):** normally connected by A3W3 to A3J9. Also used to connect an external frequency standard of 5 or 10 MHz at 0 dBm to the Signal Generator.
- 9 **Line Power Module:** permits operation from 100, 120, 220, or 240 Vac. The number visible in the window displays the nominal line (Mains) voltage for which the Signal Generator is set (see Figure 2-1). The protective grounding conductor connects to the Signal Generator through this module. The line power fuse (A3F1) is inside this module and is the only part to be changed by the operator.

Figure 3-2. Rear Panel Features

SECTION III OPERATION

3-1. INTRODUCTION

This section provides complete operating information for the Signal Generator. Included are both simplified and detailed operating instructions, detailed descriptions of the front and rear panel, local and remote operator's checks, and operator's maintenance.

3-2. Panel Features

Front and rear panel features are described in detail in Figures 3-1 and 3-2.

3-3. Operating Characteristics

Table 3-1 briefly summarizes the major operating characteristics of the Signal Generator. This table is not intended to be a complete listing of all operations and ranges, but gives a general idea of the instrument's capabilities. For more information on the Signal Generator's capabilities, refer to Table 1-1, Specifications, and Table 1-2, Supplemental Characteristics. For information on HP-IB capabilities, refer to Table 3-3, Message Reference Table.

3-4. Local Operation

Information covering front panel operation of the Signal Generator is given in the sections described below. To quickly learn the operation of the instrument, begin with Operating Characteristics and Simplified Operation. (Operator's Checks can also be used to gain familiarity with the instrument.) Once familiar with the general operation of the instrument, use the Detailed Operating Instructions as a reference for more complete operating information.

Turn-On Information. Instructions relating to the Signal Generator turn-on procedure and frequency standard selection are presented to acquaint the user with the general operation of the instrument.

Simplified Operation. The instructions located on the inside of the fold provide a quick introduction to the operation of the Signal Generator. In addition, an index to the Detailed Operating Instruc-

tions is provided to direct the user to the more complete discussion of the topic of interest.

Detailed Operating Instructions. The Detailed Operating Instructions provide the complete operating reference for the Signal Generator user. The instructions are organized alphabetically by subject. They are indexed by function in Table 3-2.

3-5. Remote Operation

The Signal Generator is capable of remote operation via the Hewlett-Packard Interface Bus (HP-IB).

HP-IB is Hewlett-Packard's implementation of the IEEE Standard 488, "IEEE Standard Digital Interface for Programmable Instrumentation," also described by the identical ANSI Standard MCI.1. For a more detailed information relating to programmable control of the Signal Generator, refer to Remote (HP-IB) Operation in this section.

This section includes discussions on capabilities, addressing, input and output formats, the status byte and service request. In Table 3-4 is a complete summary of programming codes. In addition, programming examples are given in HP-IB Checks and in the Detailed Operating Instruction.

3-6. Operator's Checks

Operator's Checks are procedures designed to verify proper operation of the Signal Generator's main functions. Two procedures are provided as described below.

Basic Functional Checks. This procedure requires a 50 ohm load or attenuator, a test oscillator, and an oscilloscope. For greater assurance, a micro-wave counter and a power meter can be used. This procedure assures that most front panel controlled functions are being properly executed by the Signal Generator.

HP-IB Checks. This procedure assumes that front panel operation has been verified with the Basic Functional Checks. The procedure checks all of the applicable bus messages summarized in Table 3-3.

Table 3-1. Operating Characteristics

Frequency	Range: 2.0 to 18.0 GHz (Overrange to 18.599997 GHz) Resolution: 1 kHz 2.0 to 6.2 GHz 2 kHz 6.2 to 12.4 GHz 3 kHz 12.4 to 18.0 GHz
Output Level	Range: -120 to +10 dB in 10 dB steps Vernier: -10 to +3 dBm continuously variable
ALC	Internal, external crystal detector, or external power meter leveling.

Table 3-2. Index of Detailed Operating Instructions

3-16	ALC CONTROL Local Procedure	3-4
	Internal Leveling	3-4
	External Crystal Detector Leveling	3-4
	External Power Meter Leveling	3-5
	Remote Procedure	3-5
	Comments	3-7
3-17	AMPLITUDE MODULATION Local Procedure	3-8
	Remote Procedure	3-8
	Comments	3-8
3-18	FREQUENCY CONTROL Local Procedure	3-10
	Remote Procedure	3-10
	Comments	3-12
3-19	FREQUENCY MODULATION Local Procedure	3-14
	Remote Procedure	3-14
	Comments	3-14
3-20	LEVEL CONTROL Local Procedure	3-17
	Remote Procedure	3-17
	Comments	3-18
3-21	PEAK-NORM ADJUSTMENT Local Procedure	3-20
	Comments	3-20
3-22	RF ON-OFF SWITCH Local Procedure	3-21
	Remote Procedure	3-21
	Comments	3-21

3-7. Operator's Maintenance

WARNING

For continued protection against fire hazard, replace the line fuse with a 250V fuse of the same rating only. Do not use repaired fuses or short-circuited fuseholders.

Operator's maintenance consists of replacing defective primary fuses. This fuse is located in the line module assembly. Refer to Figure 2-1 for instructions on changing the fuse.

To mechanically zero the front panel meter, set the LINE switch to STANDBY and place the Signal Generator in its normal operating position. Turn the mechanical zeroing adjustment (located directly beneath the meter) clockwise to move the needle up scale or counter-clockwise to move the needle down scale. The zero point is located at the left end of the 0—1 or the 0—3 scale. DO NOT zero on the left end of the top dBm scale at —10.

3-8. TURN-ON INSTRUCTIONS

WARNING

Before the instrument is switched on, all protective earth terminals, extension cords, autotransformers and devices connected to it should be connected to a protective earth grounded socket. Any interruption of the protective earth grounding will cause a potential shock hazard that could result in personal injury.

Only 250V normal blow fuses with the required rated current should be used. Do not use repaired fuses or short circuit fuseholders. To do so could cause a shock or fire hazard.

CAUTION

Before the instrument is switched on, it must be set to the voltage of the power source or damage to the instrument may result.

⚠ The Signal Generator's RF OUTPUT is protected against reverse power applications up to 1W. However, for greatest protection of expensive internal components, be careful not to apply any reverse power to the RF OUTPUT.

3-9. Turn-On

Turn-On Procedure. The Signal Generator has a STANDBY state and an ON state. In STANDBY, power goes only to an oven to provide a stable operating temperature for the reference oscillator. When ON, the entire instrument is energized. If the Signal Generator is already plugged in, set the LINE switch to ON.

If the power cable is not plugged in, follow these instructions.

On the rear panel:

1. Check the line voltage switch for correct voltage selection.
2. Check that the fuse rating is appropriate for the line voltage used (see Figure 2-1). Fuse ratings are printed on the rear panel.

Turn-On (cont'd)

3. Plug in the power cable.
On the front panel, set the LINE switch to ON.

NOTE

The OVEN COLD status annunciator should light to indicate that the Signal Generator requires warming up. The annunciator should turn off within fifteen minutes and the Signal Generator should be ready for general use.

Turn-On Configuration. When turned on after a complete power loss or after being switched to STANDBY, the Signal Generator always returns to the frequency previously displayed.

3-10. Frequency Standard Selection

A FREQ STANDARD INT/EXT switch and two connectors are located on the rear panel. A jumper normally connects the FREQ STANDARD INT connector (A3J9) to the FREQ STANDARD EXT connector (A3J10). The FREQ STANDARD EXT connector can accept a reference signal to be used instead of the Signal Generator's internal reference oscillator.

When the FREQ STANDARD INT/EXT switch is in the INT position and the jumper is connected between A3J9 and A3J10, the internal reference oscillator is enabled.

When the FREQ STANDARD INT/EXT switch is in the EXT position and the jumper is disconnected from the FREQ STANDARD EXT connector, a frequency standard of 5 or 10 MHz at 0 dBm (nominal) can be connected.

NOTE

The EXT REF status annunciator on the front panel will light when an external reference is being used. Also, the ϕ UNLOCKED status annunciator may light if the external reference is not of sufficient accuracy in frequency or has an insufficient power level. The external reference must be within ± 200 Hz of 10 MHz or ± 100 Hz of 5 MHz for reliable locking to occur. If the external reference level is not within the specified limits (0.1 to 1 Vrms into 50 ohms), its level may be sufficient to turn off the ϕ UNLOCKED status annunciator. However, the phase noise of the Signal Generator may be degraded.

FRONT PANEL FEATURES

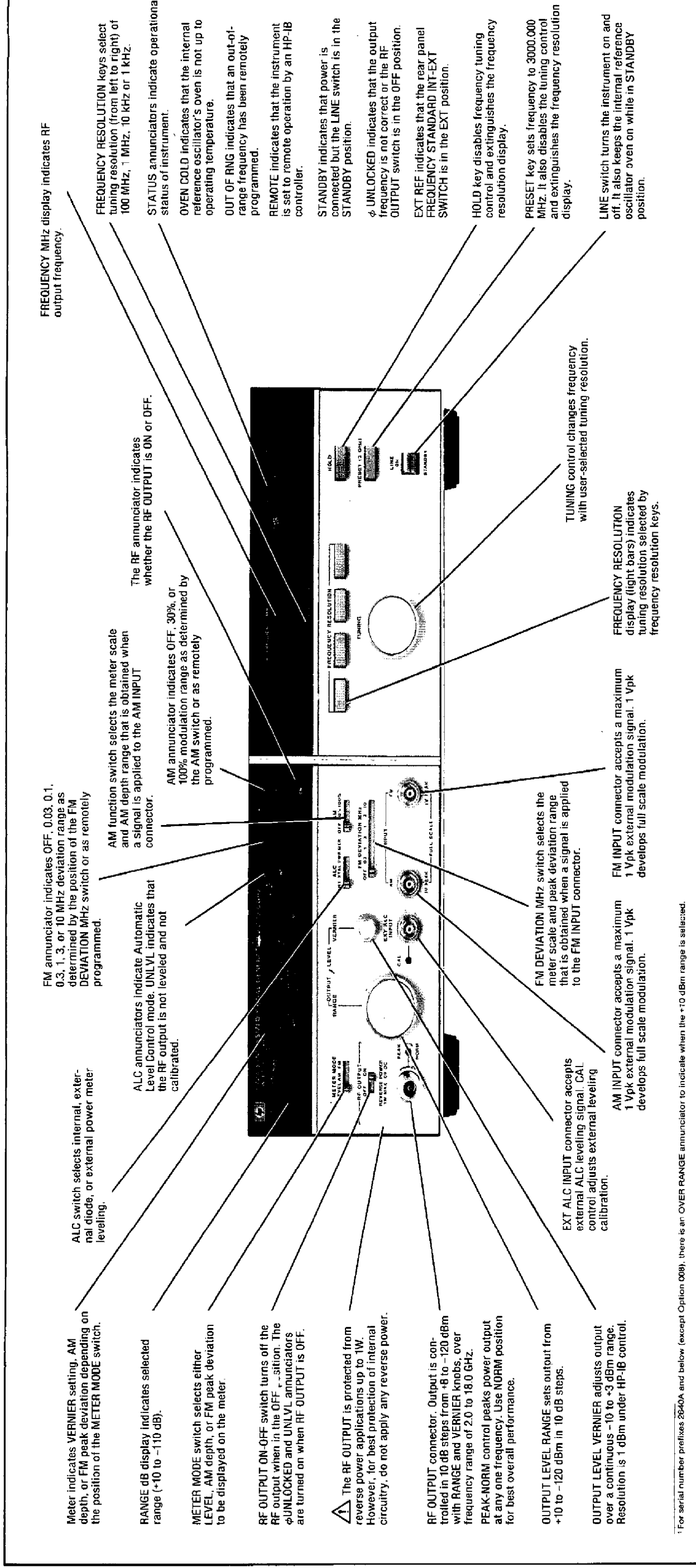

For serial number prefixes 2640A and below (except Option 008), there is an OVER RANGE annunciator to indicate when the +10 dBm range is selected.

Figure 3-1. Front Panel Features

3-11. SIMPLIFIED OPERATION

3-12. Frequency

Frequency is set using the FREQUENCY RESOLUTION keys and the TUNING knob. For example, to set the frequency to 15345.678 MHz:

1. Press PRESET (3 GHz). This is not always necessary, but it will set the right-hand six digits to 0, and may provide a convenient starting point.
2. Select the 100 MHz FREQUENCY RESOLUTION key and adjust the TUNING knob for a frequency of 15300.000 MHz.
3. Select the 1 MHz FREQUENCY RESOLUTION key and adjust the TUNING knob for a frequency of 15345.000 MHz. Select the 10 kHz FREQUENCY RESOLUTION key and adjust the TUNING knob for a frequency of 15345.670 MHz.
4. Select the 1 kHz FREQUENCY RESOLUTION key and adjust the TUNING knob for a frequency of 15345.678 MHz.
5. Press HOLD to disable the TUNING knob.

3-13. Output Level

The output level is set with the OUTPUT LEVEL RANGE and VERNIER controls.

First, adjust RANGE to step the output level up or down by increments of 10 dB. The selected range is shown in the RANGE dB display.

Adjust VERNIER between -10 and +3 dBm, as read on the meter, for the desired output level.

The output level is determined by adding the RANGE dB display to the LEVEL dBm meter reading.

3-14. ALC (Automatic Level Control)

ALC (automatic level control) has three modes of operation. They are:

INT (Internal leveling)

XTAL (External leveling using a crystal diode detector)

PWR MTR (External leveling using a power meter)

Internal leveling is selected for most applications. In this mode, a detector senses the level internally and the internal leveling circuitry keeps the output level constant. Loss of leveling is indicated by the UNLVL annunciator.

For external leveling a crystal diode detector or power meter can be used. Operation is described further in the Detailed Operating Instructions.

3-15. Modulation

Two types of modulation are available: amplitude modulation (AM), and frequency modulation (FM). Both types require an external drive signal. Front panel switches select AM depth range in percent or FM peak deviation range in MHz. Modulation varies linearly with the peak amplitude of the input signal; 1 Vpk develops full-scale modulation.

3-16. ALC CONTROL

Description The Synthesized Signal Generator has three modes of Automatic Level Control (ALC):
INT (Internal leveling)
XTAL (External leveling using a crystal diode detector)
PWR MTR (External leveling using a power meter)

For most applications internal ALC (INT) will be used. With internal ALC the output power remains constant over the entire 2 to 18 GHz frequency range.

External ALC is used when the power level at a remote point must be kept constant. External ALC reduces power variations due to external cables and connectors.

The ALC switch selects the leveling mode. Positive or negative detectors can be used to supply the external ALC input voltage. A calibration adjustment allows the externally leveled power to be adjusted to match the VERNIER setting over a limited output power range. The calibration adjustment does not affect internal leveling.

ALC mode and status are indicated by the ALC display. The display indicates which leveling source is selected and when the output is unlevelled. The status of the ALC, whether leveled or unlevelled, can also be determined remotely by reading the status byte.

Local Procedure

To use Internal Leveling:

Set the ALC selector to INT. The output level will be the sum of the range and VERNIER settings.

To use XTAL (External Crystal) Leveling:

1. Connect the crystal detector and the 10 dB coupler as shown in Figure 3-3.
2. Set the ALC selector to INT and adjust the VERNIER to read 0 dBm on the meter. This allows calibration of the meter to the leveled point.
3. Set the output level range to 0 dB and the ALC selector to XTAL.
4. Adjust the ALC CAL control to set the level read on the power meter to the nearest 10 dBm. If the ALC control does not have enough range for a low power level adjustment, step the RANGE down until the adjustment can be made.

This level should be within -3 dB and $+10$ dB of the desired level. This calibrates the meter to agree with the leveled power. If the detector is operating in the square law

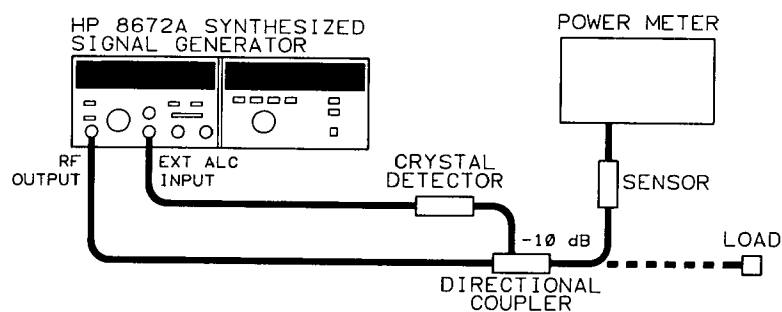

Figure 3-3. External Leveling with a Crystal Detector

ALC CONTROL (cont'd)**Local
Procedure
(cont'd)**

region, the VERNIER will now control the level over a continuous 13 dB range, and the Signal Generator's meter reading will track with the power meter reading as the VERNIER control is varied through the -10 to $+3$ dBm range.

To use external power meter leveling:

1. Set the ALC selector to INT and adjust the VERNIER to read 0 dBm on the meter. This allows calibration of the Signal Generator's meter to the leveled point.
2. Connect the power meter to the point where leveling is to be used as shown in Figure 3-4. A directional coupler can be used to sample the power at the desired point. Set the output level to the desired power and select the range hold function on the power meter. This disables range changes and keeps the leveled power from oscillating.
3. Connect the recorder output of the power meter to the external ALC input connector. The recorder output is a voltage that is proportional to the measured power in watts. This voltage varies from 0 to 2 volts for each power meter range. Leveling as low as -60 dBm can be accomplished with a sensitive power sensor using this method.
4. Set the output level range to 0 dB and the ALC selector to PWR MTR.
5. Adjust the ALC CAL controls to set the level read on the power meter to the nearest 10 dBm. This level should be within -3 dB and $+10$ dB of the desired level (minus the coupling factor of the directional coupler). This calibrates the Signal Generator's meter to agree with the leveled power. This power leveling method has a slow settling time but has the advantage of high sensitivity and temperature compensation.

If the ALC CAL control does not have enough range for a low power level adjustment, step the RANGE down until the adjustment can be made.

**Remote
Procedure**

The ALC program code controls the function of the RF output ON/OFF switch, the ALC selector and the $+10$ dB range of output power. The program string consists of the letter O followed by a single argument representing the desired combination of the control positions.

To set the Signal Generator to the $+10$ dB range, you must first set it to 0 dB with the range command (code and argument) K0. Then you can set the $+10$ dB range with the appropriate ALC command.

The codes are summarized in the table under Program Codes.

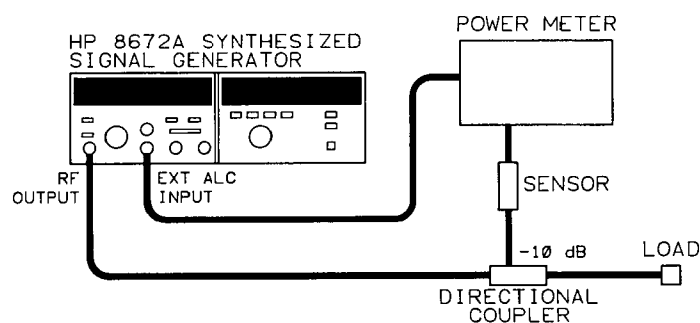

Figure 3-4. External Leveling with a Power Meter

ALC CONTROL (cont'd)

Example To set internal ALC with an output level of +3 dBm:

Local

Set ALC selector to INT, RF output to ON, range to 0 dB and VERNIER for +3 dBm.

Or

Set ALC selector to INT, RF output to ON, range to +10 dB and VERNIER to -7 dBm.

HP-IB

K 0 L 0 O 1

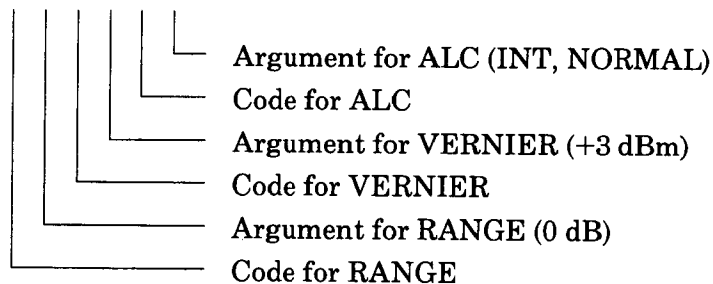

K 0 L : O 3

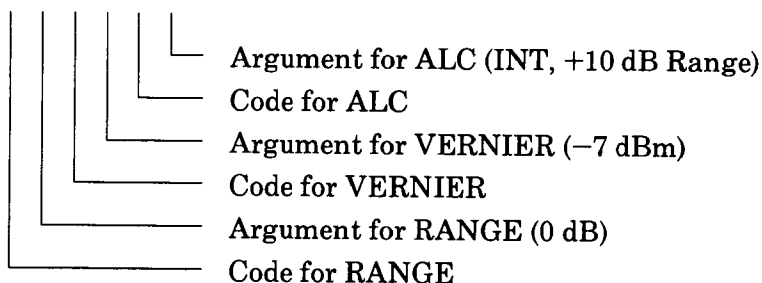

Program Codes

HP-IB

Program Code	ALC Mode			Argument
	RF	RANGE	ALC	
O or _ (letter O, not zero)	OFF	NORM	INT	0
			XTAL	4
	ON	+10	PWR MTR	<
			INT	2
ON	NORM	XTAL	6	
		PWR MTR	>	
ON	+10	INT	1	
		XTAL	5	
ON	NORM	PWR MTR	=	
		INT	3	
ON	+10	XTAL	7	
		PWR MTR	?	

ALC CONTROL (cont'd)**Comments**

Output level flatness is dependent on the ALC circuitry and the maximum available power. In order to have a leveled output it is necessary for the ALC circuitry to continuously control the output level. This can only occur if the selected output power is below the maximum power level available at each frequency. For leveled output power in the +10 dB range, it is necessary that the UNLVL annunciator remain off.

External ALC leveling also requires that the Signal Generator produce enough power to overcome losses in the intervening circuitry. The UNLVL annunciator must remain off to achieve leveling. The 0 dB range should be used when using external leveling. If any of the lower ranges are used, the Signal Generator must produce a higher level to overcome the attenuation introduced by the range selected.

For output level settings above +8 dBm¹, spurious oscillations can occur, resulting in sidebands on the carrier at a level of -30 to -50 dBc. These oscillations occur only over small portions of the frequency range. They can usually be eliminated by performing a PEAK-NORM adjustment or by reducing the output level VERNIER setting 1 or 2 dB.

Typical output level switching times are detailed under Level Control. Enabling the RF output requires less than 30 milliseconds. Disabling the RF output can be accomplished in less than 5 milliseconds.

The state of the RF output (on or off) and the status of the +10 dB range (selected or not selected) can be obtained by reading the status byte. The status of the ALC circuitry (leveled or not leveled) can also be monitored by reading the status byte. Once the status byte indicates that the output is leveled, an application can continue without waiting the specified time for the output level to settle.

Related Sections

Level Control
PEAK-NORM Adjustment

¹For serial number prefixes of 2640A or below (except Option 008), spurious oscillations can occur at output level settings above +3 dBm.

3-17. AMPLITUDE MODULATION

Description Amplitude modulation is selected using either front panel switches or remote programming. Two ranges of AM depth are selectable: 30% and 100%. The front panel meter can be used to monitor the AM depth. Allowable depths are: 0 to 75% between 2 000 MHz and 6 200 MHz, 0 to 60% between 6 200 MHz and 12 400 MHz, and 0 to 50% between 12 400 and 18 000 MHz. Specified AM rates are from 10 Hz to 100 kHz.

An external signal source is required for amplitude modulation. The source should have a variable output of 0 to 1 Vpk into 600Ω, a frequency range of 10 Hz to 100 kHz, and distortion of <1%.

Local Procedure

1. Set the METER MODE switch to AM.
2. Connect an external signal source with a 600 Ohm output impedance to the AM INPUT connector. Set the external source's amplitude to 0 and frequency to the modulation rate desired.
3. Set the Signal Generator's AM switch to 30% or 100%. The meter should indicate 0 on the 0—3 or 0—1 scale.
4. Set the OUTPUT LEVEL RANGE control and the OUTPUT LEVEL VERNIER control for the RF output level desired. For optimum AM performance, use VERNIER settings of 0 dBm and below.
5. Increase the external source's amplitude until the desired percent modulation is indicated on the Signal Generator's AM meter. 1 Vpk develops full-scale modulation.

Remote Procedure

The Signal Generator accepts a programming code and arguments for both ranges of AM depth and AM off. The program string consists of the program code followed by a single argument representing the desired range of AM depth. AM meter mode cannot be remotely programmed. To select AM meter mode while the Signal Generator is in remote mode, use the METER MODE switch on the Signal Generator's front panel.

Example

To modulate the Signal Generator at 40% AM depth:

Local

1. Set the METER MODE switch to AM.
2. Set the AM switch to 100%.
3. Connect an external signal source to the AM INPUT connector.
4. Adjust the external source's amplitude until the Signal Generator's meter indicates 40% AM depth.

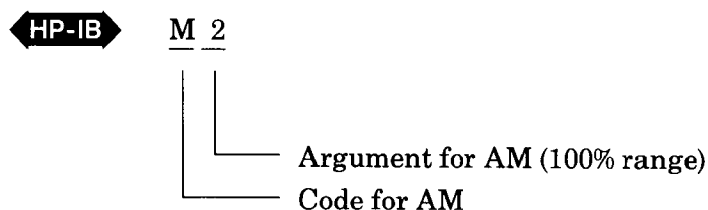

AMPLITUDE MODULATION (cont'd)

Program Codes

HP-IB

	Program Codes	Arguments
AM	M or J	OFF 0 or 1
		100% 2
		30% 3

Comments

For minimum AM distortion, the VERNIER must be set to a level meter reading of 0 dBm and below with modulation rates of less than 10 kHz.

Additional AM depth at high RF output levels (+10 dB range) may be achieved by peaking the RF output signal with the PEAK-NORM control to increase the available power. See PEAK-NORM ADJUSTMENT (paragraph 3-21) for more information.

Care must be taken to prevent AM overmodulation. AM overmodulation will occur when the AM depth causes the RF output power to exceed the instrument specifications. This can occur in one of two ways:

1. At high RF output levels (+10 dB range), the peak of the modulated signal may be clipped due to insufficient power available from the Signal Generator.
2. At low VERNIER settings (for example, -10 dBm), the AM modulator drive may not be sufficient to attenuate the modulated signal.

AM overmodulation is detected as an uncalibrated output level. The ALC UNLVL annunciator will light and the LEV UNCAL bit of the status byte will be set. If AM overmodulation occurs, reduce the AM depth until the ALC UNLVL annunciator extinguishes. At high RF output levels, peaking the RF output signal with the PEAK-NORM control may increase the RF output level enough to stop the clipping and correct the overmodulation condition.

3-18. FREQUENCY CONTROL

Description The Signal Generator uses a simple, convenient frequency tuning system.

All frequencies can be remotely programmed or entered manually by a tuning knob. The knob can be turned in either direction without encountering a mechanical stop. Also, the faster it is turned the greater the frequency change per revolution.

In addition, four degrees of coarse to fine tuning can be selected. Frequency resolution keys located above the tuning knob select 100 MHz, 1 MHz, 10 kHz or 1 kHz tuning increments. Due to frequency multiplication to generate frequencies above 6.2 GHz, the minimum tuning increment (resolution) is 2 kHz above 6.2 GHz and 3 kHz above 12.4 GHz.

Once a desired frequency has been set, pressing the HOLD key will disable the tuning control and prevent unintentional changes in the frequency. The preset key sets the output frequency to 3000.000 MHz for conveniently setting the least significant digits to zeroes.

When the Signal Generator is turned off or the power cable is removed, the last frequency setting is stored in battery-powered memory. When the instrument is powered up, the frequency returns to the stored value. This feature maintains the frequency setting even after power failures or extended periods without power.

Local Procedure

To set the output frequency to any desired frequency:

1. Press PRESET (3 GHz). This is not always necessary, but it will set the right-hand six digits to 0, and may provide a convenient starting point.
2. Select the desired tuning increment (100 MHz, 1 MHz, 10 kHz, or 1 kHz) by pressing the appropriate FREQUENCY RESOLUTION key, and use the TUNING knob to set the frequency digits above the rightmost lighted segment in the frequency resolution display.
3. Once the desired frequency is set, press the HOLD key to disable the TUNING knob.

Remote Procedure

The Signal Generator accepts any frequency within its range (2000.000 to 18599.997 MHz) to 8 significant digits. Above 6.2 GHz the frequency is randomly rounded up or down to be compatible with the 2 kHz or 3 kHz resolution at the programmed frequency.

The Signal Generator ignores spaces, commas, decimal points, carriage returns and line feeds.

Within the Signal Generator, frequency information is stored in two separate blocks of four digits each. The effects of programming codes on the two internal frequency data blocks are shown in Figure 3-5. One block contains the 10 GHz through 10 MHz frequency digits and the other contains the 1 MHz through 1 kHz digits. Programming within one block does not change the other blocks unless it is necessary to round off a frequency above 6.2 GHz. The programming codes indicate the most significant digit being programmed.

The output frequency does not change until the frequency execute command (Z1) is received by the Signal Generator. This command must be sent sometime after the frequency data has been sent.

FREQUENCY CONTROL (cont'd)

Example

To change frequency from 3000.231 MHz to 3450.001 MHz:

Local

1. Press the 100 MHz (leftmost) FREQUENCY RESOLUTION key. Adjust TUNING for a frequency of 3400.000 MHz.
2. Press the 1 MHz (next) FREQUENCY RESOLUTION key. Adjust TUNING for a frequency of 3450.000 MHz.
3. Press the 1 kHz (rightmost) FREQUENCY RESOLUTION key. Adjust TUNING for a frequency of 3450.001 MHz.

HP-IB

Q 3450001 Z 1

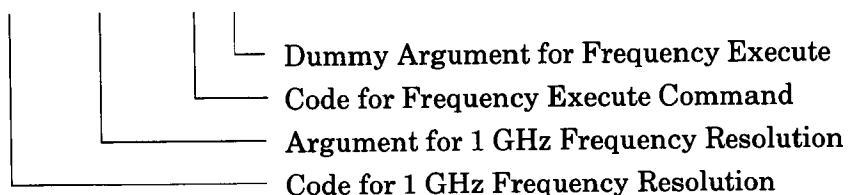

— or —

R 450001 Z 1

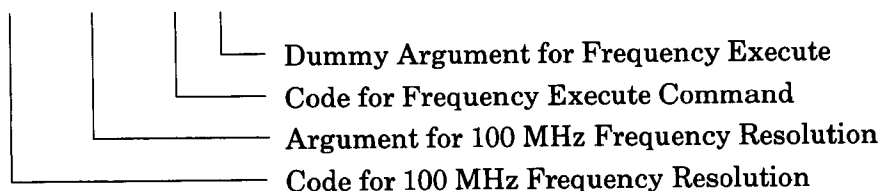

— or —

R 45 W 1 Z 1

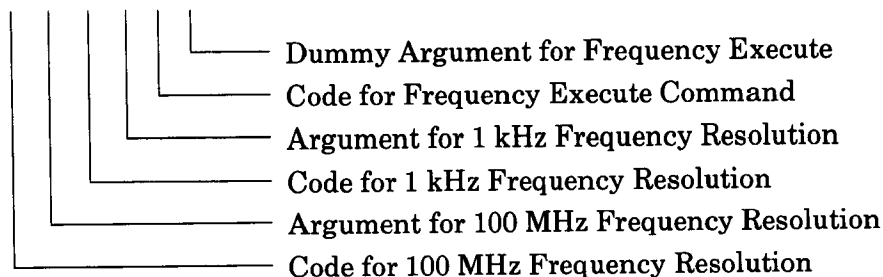

Program Codes

HP-IB

	PROGRAM CODES		ARGUMENTS
FREQUENCY	10 GHz	@ or P	0 THROUGH 9
	1 GHz	A or Q	
	100 MHz	B or R	
	10 MHz	C or S	
	1 MHz	D or T	
	100 kHz	E or U	
	10 kHz	F or V	
	1 kHz	G or W	
EXECUTE	J or Z		

FREQUENCY CONTROL (cont'd)

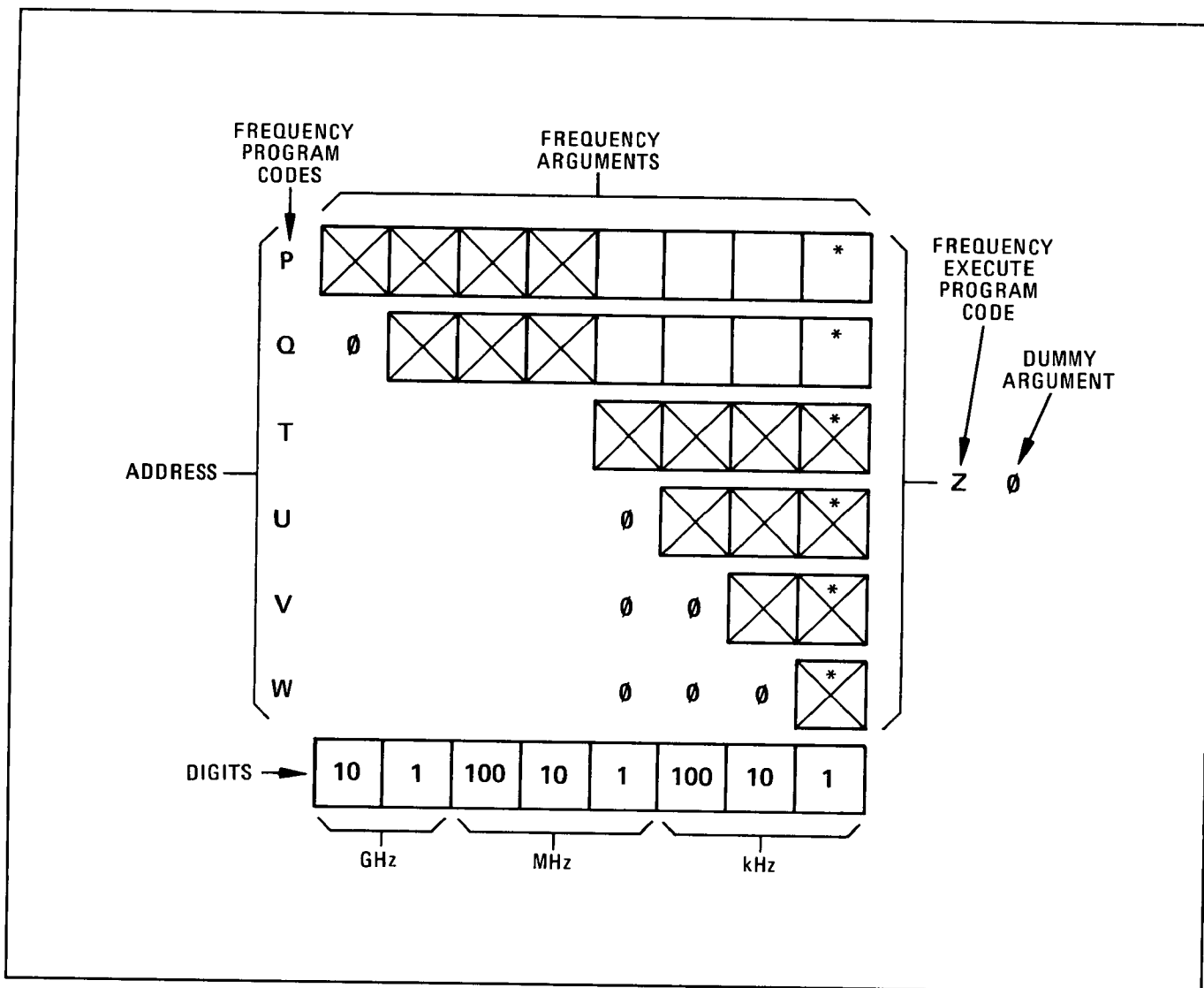

Figure 3-5. Frequency Programming Codes and Arguments

Comments

Due to the use of frequency multiplication to generate frequencies above 6.2 GHz, the frequency sometimes cannot be set precisely to a desired value. Frequencies between 2 and 6.2 GHz can be set to the nearest 1 kHz. All frequencies between 6.2 and 12.4 GHz can be set within 1 kHz of the desired value. All frequencies between 12.4 and 18 GHz can be set within 2 kHz of the desired frequency.

When the Signal Generator is programmed to a frequency that is not evenly divisible, a random roundoff occurs. As a result, the Signal Generator output frequency can be different from the programmed frequency by as much as the frequency resolution. To prevent this, the remote program should perform a calculation to determine whether the frequency can be set exactly and adjust the programmed frequency accordingly.

To determine whether a frequency can be set to a given value, divide the desired frequency (in kHz) by two if it is between 6.2 and 12.4 GHz, or by three if it is above 12.4 GHz. If the result is a whole number (with no remainder) the frequency can be set to the

FREQUENCY CONTROL (cont'd)

Comments (cont'd)

desired value. For example, 16 GHz divided by three (it is above 12.4 GHz) is 5333333.33 kHz, so this frequency cannot be set exactly. The nearest frequencies that can be set are 15.999999 GHz (5.333333×3) and 16.000002 GHz (5.333334×3).

The time it takes to switch from one frequency to the next depends on the largest frequency digit being changed. Generally, the smaller the digit being changed, the shorter the switching time. Typical switching times by largest digit being changed for frequencies between 2 and 6.2 GHz can be summarized as follows:

Largest Digit Changed	Time to be Within 1 kHz
100 MHz	10 ms
10 MHz	10 ms
1 MHz	10 ms
100 kHz	5 ms
10 kHz	3 ms
1 kHz	1.5 ms

For frequencies above 6.2 GHz, actual frequency digits being changed must be determined by dividing the output frequency by two (6.2 to 12.4 GHz) or three (12.4 to 18 GHz). The actual data transfer time is only a small portion of the frequency switching time and can be ignored.

For applications that require fast execution, the status byte can be checked until the frequency is phase locked. Once the status byte indicates that the Signal Generator is phase locked, the application may continue with the assurance that the frequency is correct. Figure 3-6 shows the typical worst case lock and settling times.

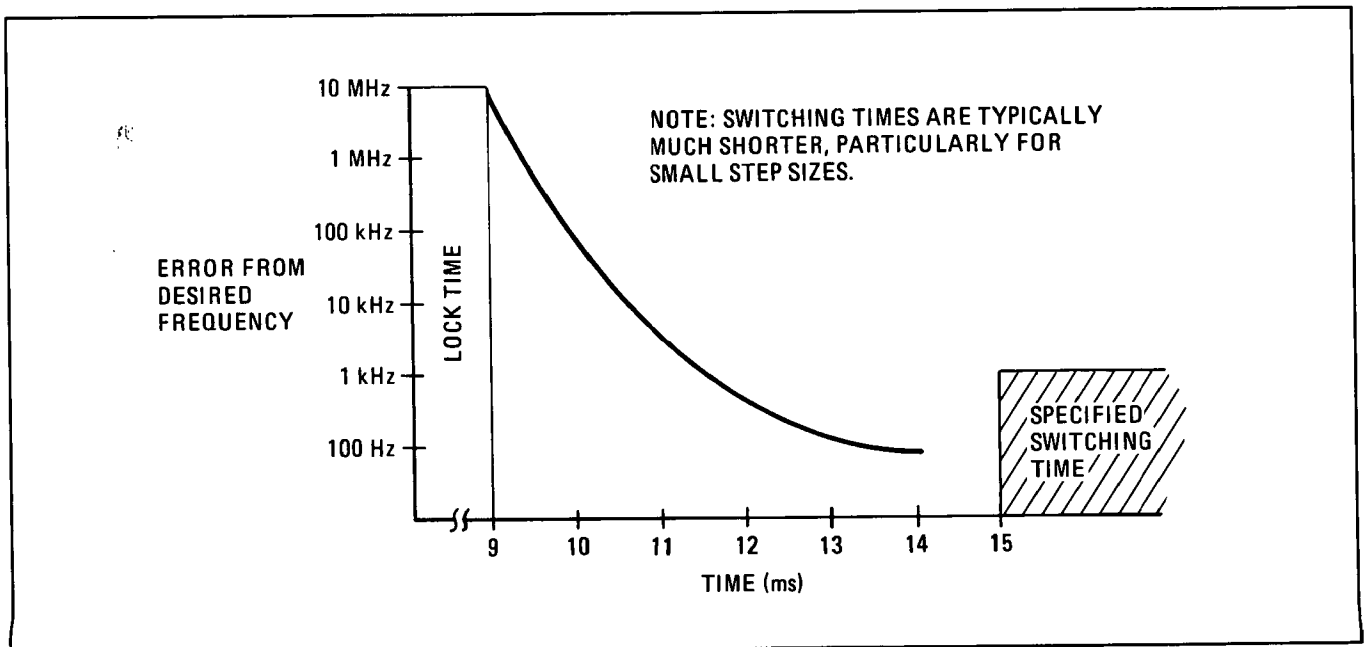

Figure 3-6. Frequency Switching Time Showing Worst Case

3-19. FREQUENCY MODULATION

Description

Frequency modulation is selected using either front panel switches or remote programming. Six ranges of FM deviation sensitivity are selectable: 0.03, 0.1, 0.3, 1, 3, and 10 MHz/V. FM peak deviation can be monitored with the front panel meter. At output frequencies below 6 200 MHz, peak deviation is limited to 10 MHz or five times the modulation frequency whichever is lower. From 6 200 to 12 400 MHz, peak deviation is limited to the lesser of 10 MHz or ten times the modulation frequency. From 12 400 to 18 000 MHz, peak deviation is limited to the lesser of 10 MHz or fifteen times the modulation frequency.

An external signal source is required for frequency modulation. The source should have a variable output of 0 to 1 Vpk into 50Ω, a frequency range of 50 Hz to 10 MHz, and distortion of <1%.

Local Procedure

1. Set the **METER MODE** switch to FM.
2. Connect an external signal source with a 50 Ohm output impedance to the FM input connector. Set the external source's amplitude to 0 Vrms and frequency to the modulation rate desired.
3. Set the Signal Generator's **FM DEVIATION MHz** switch to the desired deviation range. The front panel meter should indicate 0 on the 0 to 1 or 0 to 3 scale.
4. Set the **OUTPUT LEVEL RANGE** control and the **OUTPUT LEVEL VERNIER** control to the RF output level desired.
5. Increase the external source's amplitude until the desired peak deviation is displayed on the Signal Generator's meter. 1 Vpk develops full-scale modulation.

Remote Procedure

The Signal Generator accepts a programming code and arguments for all ranges of FM deviation and FM off. The program string consists of the program code N followed by a single argument representing the desired FM deviation range.

Example

To modulate the Signal Generator at 2 MHz peak deviation:

Local

1. Set the **METER MODE** switch to FM.
2. Set the **FM DEVIATION MHz** switch to 3.
3. Connect an external signal source to the **FM INPUT** connector.
4. Adjust the external source's amplitude until the Signal Generator's meter indicates 2 MHz peak deviation.



N 1



Argument for FM (3 MHz range)
Code for FM

FREQUENCY MODULATION (cont'd)

Program Codes

HP-IB

	Program Codes	Arguments	
FM	N	OFF	6 or 7
		30 kHz	5
		100 kHz	4
		300 kHz	3
		1 MHz	2
		3 MHz	1
		10 MHz	0

Comments

Maximum FM peak deviation is a function of the modulation frequency. At low modulation rates using large peak deviations (high modulation index), the Signal Generator's frequency generation circuitry cannot maintain phase lock. At high modulation rates (low modulation index), the effective bandwidth of the RF output limits the peak deviation. The RF output effective bandwidth (due to internal filtering) limits the usable peak deviation to 10 MHz.

Modulation index (M) is defined as:

$$M = \frac{\Delta f_{\text{peak}}}{f_{\text{mod}}}$$

Where:

- M = Modulation index
- f_{peak} = FM peak deviation in kHz.
- f_{mod} = Modulating frequency in kHz.

Maximum specified modulation indexes are: 5 between 2.0 and 6.2 GHz, 10 between 6.2 and 12.4 GHz, and 15 between 12.4 and 18.0 GHz. See Figure 3-7 to determine maximum FM peak deviation for a given modulation rate and Signal Generator frequency.

FM overmodulation occurs when the frequency generation circuitry of the Signal Generator cannot track the external modulating frequency. This can occur in one of two ways:

1. The amplitude of the external modulating signal exceeds 1.2 Vpk.
2. The modulation index is too high.

When FM overmodulation is detected, the FM OVERMOD annunciator will light and the FM OVERMOD bit of the status byte will be set. If FM overmodulation occurs, adjust the amplitude or the frequency of the external modulation source until the annunciator extinguishes.

Calibration of the FM circuitry is performed at 100 kHz. For this reason the FM specifications are referenced to a 100 kHz modulation rate. The frequency response of the FM circuitry, however, causes variations in actual FM peak deviation for modulation rates other than 100 kHz. For example, when the modulation signal amplitude is held constant and the modulating frequency is varied, the actual FM peak deviation will

FREQUENCY MODULATION (cont'd)

Comments (cont'd)

change due to the frequency response of the FM circuitry. The FM meter, however, monitors the amplitude of the modulation signal at the FM INPUT connector and will not indicate the variations in peak deviation due to the frequency response of the FM circuitry. At modulation rates other than 100 kHz, the FM circuitry frequency response must be taken into account when reading the FM meter. To determine the FM meter accuracy, add the FM frequency response specification to the indicated meter accuracy specification. FM frequency response specification gives the range of input power at the FM input connector required to maintain a constant FM peak deviation.

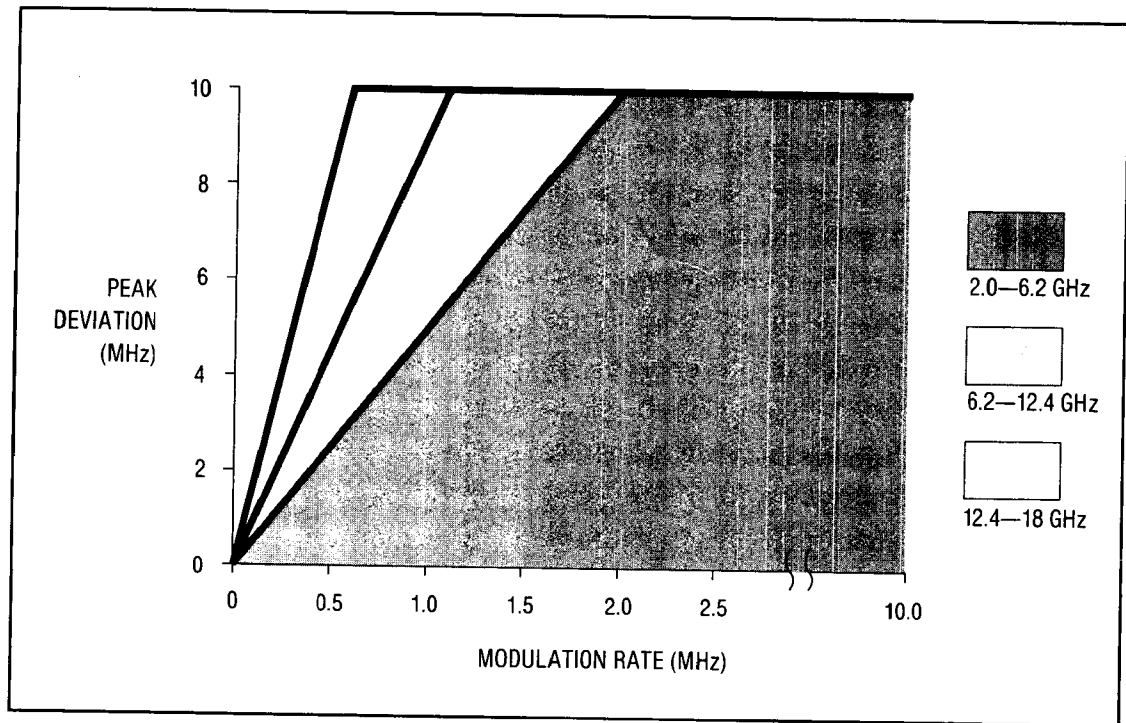

Figure 3-7. Possible FM Rates and Frequency Deviations

3-20. LEVEL CONTROL

Description The Synthesized Signal Generator is calibrated over a wide range of output power levels from +8 dBm to -120 dBm. The output level is set with a RANGE selector and a VERNIER control. The output level is the sum of the settings of these two controls.

The RANGE selector varies the output level in 10 dB steps. The selected range (+10 dB to -110 dB) is digitally displayed in the RANGE display. This display indicates the selected range in both local and remote modes. Output level ranges of 0 dB to -110 dB are programmable with the range program code. The +10 dB range is selected using the ALC program code.

The VERNIER knob continuously varies the output level in the 0 dB range from -10 to +3 dBm. The VERNIER setting is indicated by the front panel meter.

In local mode the VERNIER can be varied continuously over the full 13 dB range. In remote mode the VERNIER can be programmed in fourteen 1 dB steps from -10 dBm to +3 dB. Because the VERNIER can be controlled over greater than 10 dB in both local and remote mode, it is possible to overlap range settings by 3 dB. This is useful in applications where the ability to vary the output power continuously about a given level is critical.

Local Procedure

To set the output level to any desired value:

1. Set the Signal Generator ALC mode to internal (INT).
2. Set the OUTPUT LEVEL RANGE to within -3 to +10 dB of the desired output level. For example, for a -56 dBm output level choose the -50 dB range.
3. Adjust the OUTPUT LEVEL VERNIER setting until the sum of the range display and the meter is equal to the desired output level.

Some output levels may be set using either of two adjacent ranges. Either range may be used. For example, +3 dBm may be set with a 0 dB range and +3 dBm VERNIER setting or a +10 dB range and -7 dBm VERNIER setting.

Setting output levels above +8 dBm may cause an ALC unlevelled condition due to insufficient power available. The meter will indicate the actual power available when the unlevelled condition occurs.

Remote Procedure

The 0 dB to -110 dB ranges and the VERNIER setting are programmed with the output level program codes. The VERNIER setting is programmed in 1 dB steps from -10 dBm to +3 dBm. The range is programmed in 10 dB steps from 0 dB to -110 dB. The +10 dB range is programmed by setting RANGE to 0 dBm and ALC to +10 dB.

When switching from local to remote mode, the VERNIER is reset to -10 dB and the range remains unchanged.

Example

To set the output level to +3 dBm:

Local

Set RANGE to 0 dB and VERNIER to +3 dBm.

Or

Set RANGE +10 dB and VERNIER to -7 dBm.

LEVEL CONTROL (cont'd)

**Example
(cont'd)**



K 0 L 0

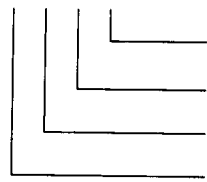

Argument for VERNIER (+3 dBm)
Code for VERNIER
Argument for RANGE (0 dB)
Code for RANGE

K 0 L : 0 3

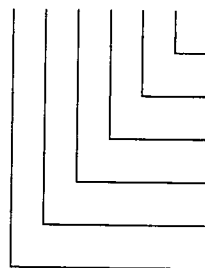

Argument for ALC (INT, +10 dB Range)
Code for ALC
Argument for VERNIER (-7 dBm)
Code for VERNIER
Argument for RANGE (0 dB)
Code for RANGE

**Program
Codes**



	Program Codes	Arguments
OUTPUT LEVEL RANGE	K	0 dBm 0
		-10 1
		-20 2
		-30 3
		-40 4
		-50 5
		-60 6
		-70 7
		-80 8
		-90 9
		-100 :
		-110 ;

	Program Codes	Arguments
OUTPUT LEVEL VERNIER	L	+3 dB 0
		+2 1
		+1 2
		0 3
		-1 4
		-2 5
		-3 6
		-4 7
		-5 8
		-6 9
		-7 :
		-8 ;
-9 <		
-10 =		

Comments

Output level flatness is dependent on the ALC circuitry and the maximum available power. In order to have a leveled output it is necessary for the ALC circuitry to continuously control the output level. This can only occur if the selected output power is below the maximum power level available at each frequency. For leveled output power in the +10 dB range, it is necessary that the UNLVL annunciator remain off. If it lights, adjust the PEAK-NORM control, or reduce the VERNIER setting.

For output level settings above +8 dBm, spurious oscillations can occur, resulting in sidebands on the carrier at a level of -30 to -50 dBc. These oscillations occur only over small portions of the frequency range.

LEVEL CONTROL (cont'd)**Comments
(cont'd)**

They can usually be eliminated by performing a PEAK-NORM adjustment or by reducing the OUTPUT LEVEL VERNIER setting 1 or 2 dB.

External ALC leveling also requires that the Signal Generator produce enough power to overcome losses in the intervening circuitry. The UNLVL annunciator must remain off to achieve leveling. If it lights adjust the PEAK-NORM control, or decrease the VERNIER setting.

Typical output level range change execution time for a 10 dB step is less than 20 milliseconds. An output level VERNIER change of 1 dB will take less than 10 milliseconds. These times are typical for remote programming. The actual data transfer time is a very small part of the execution time and may be ignored for most controllers.

The RF output changing from enabled to disabled takes less than 5 milliseconds. To enable the RF output from a disabled state requires less than 30 milliseconds.

The state of the RF output (on or off) and the +10 dB range (selected or not selected) can be obtained by reading the status byte. These two functions are programmed along with the ALC mode. For more information see ALC Control.

**Related
Sections**

ALC Control
PEAK-NORM Adjustment

3-21. PEAK-NORM ADJUSTMENT

Description The PEAK-NORM control adjusts an internal filter for maximum power output at a single frequency. This filter is adjusted for best over-all performance with the control in the detent position (NORM), but can be adjusted for maximum power (and reduced harmonics and sub-harmonics) at any one frequency. This adjustment will result in lower maximum power at most other frequencies, and therefore should be left in the NORM position except when maximum power is needed. It should only be required at power levels above +8 dBm.

Local Procedure To maximize the output power at a set frequency:
Adjust the PEAK-NORM adjustment until the UNLVL annunciator turns off, or for maximum meter reading with the VERNIER fully clockwise.

Remote Procedure This adjustment cannot be remotely programmed.

Example To peak an output level of +10 dBm at 8 GHz due to an UNLVL indication:

1. Adjust the PEAK-NORM adjustment until the UNLVL annunciator turns off, or for maximum meter reading with the VERNIER fully clockwise.
2. Return the PEAK-NORM adjustment to NORM (detented) position before resuming normal instrument operation. The +8 dBm output power level is affected by this adjustment and is only specified with the PEAK-NORM adjustment set to NORM.

Comments For output level settings above +8 dBm, spurious oscillations can occur, resulting in sidebands on the carrier at a level of -30 to -50 dBc. These oscillations occur only over small portions of the frequency range.

They can usually be eliminated by performing a PEAK-NORM adjustment or by reducing the output level VERNIER setting 1 or 2 dB.

The PEAK-NORM adjustment must be in the NORM (detented) position to guarantee the specified +8 dBm level over the entire frequency range.

3-22. RF ON/OFF SWITCH

Description The RF ON/OFF switch provides a convenient way of turning off the output signal. This is useful when calibrating detectors, zeroing power meters, or making noise measurements with no signal applied. With the switch in the off position the internal 2 to 6.2 GHz oscillator is turned off to prevent any signal leakage to the RF output connector.

The RF annunciator indicates the position of the RF ON/OFF switch in local mode and the programmed state when in remote mode. With the internal 2 to 6.2 GHz oscillator turned off, the Signal Generator is no longer phase locked or leveled so the UNLVL and ϕ UNLOCKED annunciators are lighted.

Local Procedure

To disable the RF output:

Set the RF ON/OFF switch to OFF. Note that the OFF, UNLVL and ϕ UNLOCKED annunciators should be lighted.

To enable the RF output:

Set the RF ON/OFF switch to ON. The UNLVL and ϕ UNLOCKED annunciators should extinguish and the ON annunciator should light.

Remote Procedure

See ALC Control for a description of how to program the RF ON/OFF switch function.

Program Codes

See ALC Control

**Comments**

The status of the RF output (on or off) can be determined by reading the status byte. A service request is not generated for UNLVL or ϕ UNLOCKED when the RF output is set to OFF.

The RF output off-to-on transition typically requires less than 30 milliseconds when remotely programmed. The on-to-off transition typically requires less than 5 milliseconds.

3-23. REMOTE OPERATION

The Signal Generator can be operated through the Hewlett-Packard Interface Bus (HP-IB). HP-IB compatibility, programming and data formats are described in the following paragraphs.

All front panel functions except that of the ALCAL control, PEAK-NORM control, and LINE switch are programmable via HP-IB.

A quick test of the Signal Generator's HP-IB interface is described in this section under HP-IB Checks. These checks verify that the Signal Generator can respond to or send each of the applicable bus messages described in Table 3-3.

3-24. HP-IB Compatibility

The Signal Generator's programming capability is described by the twelve HP-IB messages listed in Table 3-3. The Signal Generator's compatibility with HP-IB is further defined by the following list of interface functions: SH1, AH1, T6, TE0, L4, LE0, SR1, RL2, PP2, DC1, DT0, and C0. A more detailed explanation of these compatibility codes can be found in IEEE Standard 488-1978 and the identical ANSI Standard MC1.1.

3-25. Remote Mode

Remote Capability. The Signal Generator communicates on the bus in both remote and local modes. In remote, the Signal Generator's front panel controls are disabled except for the LINE switch. However, front panel displays remain active and valid. In remote, the Signal Generator can be addressed to talk or listen. When addressed to listen, the Signal Generator automatically stops talking and responds to the following messages: Data, Clear (SDC), Remote, Local, and Abort. When addressed to talk, the Signal Generator automatically stops listening and sends one of the following messages: Data, Require Service, or Status Byte. Whether addressed or not, the Signal Generator responds to the Clear (DCL), Clear Lockout/Set Local, and Abort messages. In addition, the Signal Generator can issue the Require Service message and the Status Bit message.

Local-to-Remote Mode Changes. The Signal Generator switches to remote operation upon receipt of the Remote message. The Remote message has two parts. They are:

- a. Remote enable bus control line (REN) set true.

- b. Device listen address received once (while REN is true).

When the Signal Generator switches to remote, the REMOTE annunciator on the front panel turns on. With the exception of VERNIER, which will reset to -10 dBm, the Signal Generator's control settings remain unchanged with the Local-to-Remote transition.

3-26. Local Mode

Local Capability. In local, the Signal Generator's front panel controls are fully operational and the instrument will respond to a Remote message. The Signal Generator can send a Require Service message, a Status Byte message, and a Status Bit message while in the Local mode.

Remote-to-Local Mode Changes. The Signal Generator switches to local from remote whenever it receives a Local (GTL), Universal Unlisten address, Abort, or Clear Lockout/Set Local message. (The Clear Lockout/Set Local message sets the Remote Enable control line [REN] false.) The Signal Generator can also be switched to local by turning the LINE switch to STANDBY, and then to ON.

With the Remote-to-Local transition, the frequency will remain the same. All other functions will return to the front panel settings. Power may go up, go down, or stay the same.

3-27. Addressing

When the Remote Enable line (REN) and the Attention control line (ATN) are true and the Interface Clear control line (IFC) is false, the Signal Generator interprets the byte on the eight HP-IB data lines as an address or a command.

The Signal Generator's Talk and Listen addresses can be set by switches located inside the instrument. The address selection procedure is described in Section II. Refer to Table 2-1 for a comprehensive listing of all valid HP-IB address codes.

3-28. Data Messages

The Signal Generator communicates on the interface bus primarily with Data messages. Data messages consist of one or more bytes sent over the bus data lines when the bus is in the data mode (attention control line [ATN] false). The Signal Generator receives Data messages when addressed to listen, and sends the Status Byte message when

Table 3-3. Message Reference Table (1 of 2)

HP-IB Message	Appliable	Response	Related Commands and Controls	Interface Functions*
Data	Yes	Frequency, Output level (RANGE and VERNIER), and ALC mode can be programmed. The Signal Generator sends the status byte when addressed to talk.		AH1 SH1 T6, TE0 L4, LE0
Trigger	No	The Signal Generator does not respond to the Group Execute Trigger (GET) bus command	GET	DT0
Clear	Yes	Sets frequency to 3000.000 MHz, RF output to off, ALC mode to Internal, and VERNIER to -10 dBm.	DCL SDC	DC1
Remote	Yes	Remote mode is enabled when the REN bus control line is true. However, remote mode is not entered until the first time the Signal Generator is addressed to listen. The front panel REMOTE annunciator lights when the instrument is actually in the remote mode. The VERNIER is set to -10 dBm.	REN	RL1
Local	Yes	The Signal Generator returns to local mode (front panel control). The Signal Generator returns to the previous front panel settings, except for frequency.	GTL	RL2
Local Lockout	No	The Signal Generator does not respond to the local lockout command.	LLO	RL2
Clear Lockout/ Set Local	Yes	The Signal Generator returns to local (front panel control) when the REN bus control line goes false.	$\overline{\text{REN}}$	RL2
Pass Control/ Take Control	No	The Signal Generator has no controller capability.		C0
Require Service	Yes	The Signal Generator sets the SRQ bus control line true if one of the following conditions exists: frequency out of range, not phase locked with RF output on, or RF power level uncalibrated with RF power on.	SRQ	SR1
Status Byte	Yes	The Signal Generator responds to a Serial Poll Enable (SPE) bus command by sending an 8-bit status byte when addressed to talk. If the instrument is holding the SRQ control line true (issuing the Require Service message), the RQS bit and the bit representing the condition causing the Require Service message to be issued will both be true.	SPE SPD	T5
Status Bit	Yes	The Signal Generator responds to a Parallel Poll Enable (PPE) bus command by sending a status bit on a switch selected HP-IB data line.	PPE	PP2



Table 3-3. Message Reference Table (2 of 2)

HP-IB Message	Applicable	Response	Related Commands and Controls	Interface Functions*
Abort	Yes	The Signal Generator stops talking and listening.	IFC	T6, TE0 L4, LE0
*Commands, Control lines, and Interface Functions are defined in IEEE Std 488-1978. Knowledge of these may not be necessary if your controller's manual describes programming in terms of the twelve HP-IB Messages shown in the left column.				
Complete HP-IB capability as defined in IEEE Std 488 and ANSI Std MC1.1 is: SH1, AH1, T6, TE0, L4, LE0, DT0, DC1, RL2, C0, SR1, and PP2.				

Data Messages (cont'd)

addressed to talk. All instrument operations available in local mode can be performed in remote mode via Data messages except changing the ALC CAL and PEAK-NORM controls and the LINE switch setting.

3-29. Receiving Data Messages

The Signal Generator responds to Data messages when it is enabled to remote (REN control line true) and addressed to listen. The instrument remains addressed to listen until it receives an Abort message or until its talk address or a universal unlisten command is sent by the controller.

A data message is a string of alternate codes and arguments, where a code is an ASCII character representing a function, such as frequency, RF output level, or ALC mode, and an argument is an ASCII digit representing a selection of the function. Each code and its argument make a command.

A complete summary of programming formats, codes and arguments is given in Table 3-4. In addition, programming examples are given in HP-IB Checks, and in the Detailed Operating Instructions.

The Complete Data Message. The following program string is a complete data message. It lists the commands in the order that the Signal Generator decodes them, along with arguments that will be explained.

“P1Q2R3S4T5U6V7W8Z1K9L7M0N7O1”

The commands preceeding Z1 program a frequency of 12345.678 MHz. Z1 is a frequency execute command which is required to execute a string of frequency commands. K9 and L7 program output RANGE and VERNIER to -90 dB and -4 dBm respectively. M0 and N7 are used to program AM and FM respectively. The O1 command programs ALC to internal leveling.

The Abbreviated Data Message. If functions are programmed in the order listed, codes can be omitted from the string, except for the first code, and Z1, the frequency execute command, if programming frequency. Thus, the following string is equivalent to the one above.

“P12345678Z197071”

Furthermore, the string can begin with any code and end with any argument, and can be composed of combinations of this syntax. Thus, the following string will program the Signal Generator to a frequency of 2345 MHz, with a VERNIER setting of 0 dBm, without changing the output level RANGE setting.

“Q2345Z1L3”

3-30. Receiving the Clear Message

The Signal Generator responds to the Clear message by setting the frequency to 3 GHz, ALC to internal, modulation off, and RF power off. The message can take two forms: Device Clear which the Signal Generator responds to only when addressed, and Selected Device Clear, which it responds to whether addressed or not. The Device Clear message does not affect addressing, while

Receiving the Remote Message (cont'd)

the Selected Device Clear message leaves the Signal Generator addressed to listen.

3-31. Receiving the Trigger Message

The Signal Generator does not respond to the Trigger message.

3-32. Receiving the Remote Message

The Remote message has two parts. First, the remote enable bus control line (REN) is held true; second, the device listen address is sent by the controller. These two actions combine to place the Signal Generator in remote mode. Thus, the Signal Generator is enabled to go into remote when the controller begins the Remote message, but it does not actually switch to remote until addressed to listen the first time. When actually in remote, the Signal Generator's front panel REMOTE annunciator lights.

3-33. Receiving the Local Message

The Local message is the means by which the controller sends the Go To Local (GTL) bus command. The Signal Generator returns to front panel control when it receives the Local message.

When the Signal Generator goes to local mode, the front panel REMOTE annunciator turns off. However, even in local, the Signal Generator sends the status byte when addressed to talk.

3-34. Receiving the Local Lockout Message

The Signal Generator does not respond to the Local Lockout message.

**3-35. Receiving the Clear Lockout/
Set Local Message**

The Clear Lockout/Set Local message is the means by which the controller sets the Remote Enable (REN) bus control line false. The Signal Generator returns to local mode (full front panel control) when it receives the Clear Lockout/Set Local message. When the Signal Generator goes to local mode, the front panel REMOTE annunciator turns off.

3-36. Receiving the Pass Control Message

The Signal Generator does not respond to the Pass Control message because it does not have this controller capability.

3-37. Sending the Require Service Message

The Signal Generator sends a Require Service message if one or more of the following conditions exists for more than 50 ms:

- 1) Frequency programmed out of range
- 2) Not phase locked with RF output on
- 3) RF power level uncalibrated (LVL UNCAL) with RF power on.
- 4) FM overmodulated with RF power on.

The Signal Generator can send a Require Service message in either the local or remote mode, and whether or not addressed. It sends the message by setting the Service Request (SRQ) bus line true.

Once the Signal Generator is addressed to talk, the RQS bit is latched, even though the Signal Generator's need for service may have changed.

3-38. Sending the Status Byte Message

After receiving a Serial Poll Enable bus command (SPE) and when addressed to talk, the Signal Generator sends a Status Byte message. The message consists of one 8-bit byte which corresponds to the pattern shown in Table 3-4, Programming Quick Reference Guide.

3-39. Sending the Status Bit Message

The Signal Generator sends the Status Bit message in response to the Parallel Poll Enable (PPE) bus command (whether or not it is addressed to talk). If the Signal Generator is sending the Require Service message, it will set its assigned status bit true.

The data line that the parallel poll is assigned to respond on, and the sense (active high or active low) can be set from switches located inside the instrument. The selection procedure is described in Section II.

3-40. Receiving the Abort Message

The Abort message is the means by which the controller sets the Interface Clear (IFC) bus control line true. When the Abort message is received, the Signal Generator becomes unaddressed and stops talking or listening.

Table 3-4. Programming Quick Reference Guide (1 of 2)

PROGRAM STRING SYNTAX

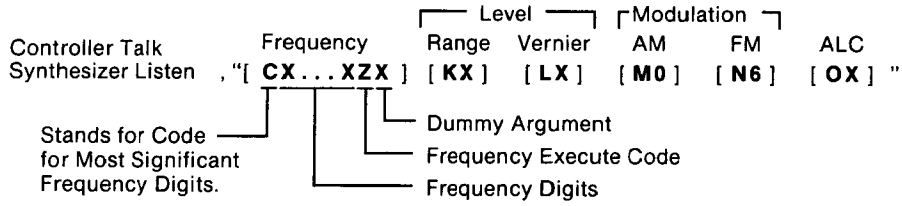

WHERE: C = PROGRAM CODE
 X = ARGUMENT OR FREQUENCY DIGIT

	PROGRAM CODES	ARGUMENTS
FREQUENCY	10 GHz @ or P	0 THROUGH 9
	1 GHz A or Q	
	100 MHz B or R	
	10 MHz C or S	
	1 MHz D or T	
	100 kHz E or U	
	10 kHz F or V	
	1 kHz G or W	
EXECUTE J or Z		
OUTPUT LEVEL RANGE	K or [0 dB 0
		-10 1
		-20 2
		-30 3
		-40 4
		-50 5
		-60 6
		-70 7
		-80 8
		-90 9
		-100 :
		-110 ;

	PROGRAM CODES	ARGUMENTS	
OUTPUT LEVEL VERNIER	L or \	+3 dBm 0	
		+2 1	
		+1 2	
		0 3	
		-1 4	
		-2 5	
		-3 6	
		-4 7	
		-5 8	
		-6 9	
-7 :			
-8 :			
-9 <			
-10 =			
AM	M or]	OFF 0 or 1 100% 2 30% 3	
FM	N or ^	OFF 6 or 7 30 kHz 5 100 kHz 4 300 kHz 3 1 MHz 2 3 MHz 1 10 MHz 0	
ALC	PROGRAM CODES	ARGUMENTS	
		ALC	RF
0 or _			OFF
		0	1
		2	3
		4	5
		6	7
		<	=
>	?		

Table 3-4. Programming Quick Reference Guide (2 of 2)

STATUS BYTE

Bit Number	8	7	6	5	4	3	2	1
Decimal Value	128	64	32	16	8	4	2	1
Function	CRYSTAL OVEN COLD	REQUEST SERVICE	OUT OF RANGE (Frequency)	RF OFF	NOT PHASE LOCKED	LEV UNCAL	0 FM OVER- MOD	+10 dB RANGE ¹

¹For serial number prefixes of 2640A and below (except Option 008), this bit is labeled "+10 dBm OVER RANGE".

OPERATOR'S CHECKS

3-41. OPERATOR'S CHECKS

3-42. Basic Functional Checks

Description The purpose of these checks is to give reasonable assurance that the instrument is operating properly.

Each check has been designed to be performed with a minimum of test equipment, and in as short a time as possible. Therefore, although these checks are extremely valuable in identifying malfunctions, they are not a substitute for the Performance Tests in Section IV, which verify that the instrument is performing within its published specifications.

Each check is independent of the others and can be performed separately.

If a malfunction is suspected and the Signal Generator is being returned to Hewlett-Packard for service, perform the entire procedure. Document the checks that failed on a blue repair tag located at the rear of this manual and attach the tag to the instrument. This will help ensure that the malfunction has been accurately described to service technicians for the best possible service.

Equipment Attenuator, 10 dB HP 8491B, Option 010
 Test Oscillator HP 8116A
 Oscilloscope HP 1980B

Procedure **Turn-On Check**

1. Set the LINE switch to STANDBY. Remove all external cables from the front and rear panels of the Signal Generator, including the power cable connecting the instrument to mains power.
2. Set the rear panel **FREQ STANDARD INT/EXT** switch to INT and connect the JUMPER (A3W3) between A3J9 and A3J10.
3. After the power cable has been disconnected from the Signal Generator for at least 1 minute, reconnect it to the Signal Generator. Check the front panel of the instrument to verify that the STANDBY and OVEN COLD status annunciators are on.
4. Leave the instrument's LINE switch set to STANDBY until the OVEN COLD status annunciator turns off. This should occur in 15 minutes or less, depending upon how long the Signal Generator was disconnected from mains power. (The OVEN COLD annunciator may flicker off and on temporarily just as the oven stabilization temperature is reached. This is normal operation.) Once the OVEN COLD status annunciator is off set the LINE switch to ON.
5. Set the RF OUTPUT switch to ON. Set the **FREQ STANDARD INT/EXT** switch to EXT. Verify that the EXT REF and ϕ UNLOCKED status annunciators turn on. Set the switch back to INT. The status annunciators should then turn off.

Frequency Check

The **FREQUENCY MHz** display and ϕ UNLOCKED status annunciator are used to check that the internal phase-lock loops remain phase locked across their tuning range. The actual frequency at the RF OUTPUT connector is not checked. However, the

OPERATOR'S CHECKS

Basic Functional Checks (cont'd)

Procedure (cont'd)

frequency can be monitored with a microwave frequency counter or spectrum analyzer for greater assurance that the Signal Generator is operating properly.

If a frequency counter is to be used to check frequency, disconnect the jumper from the rear panel connector A3J10 and connect the frequency counter as shown in Figure 3-8. Set the Signal Generator rear panel INT-EXT switch to EXT.

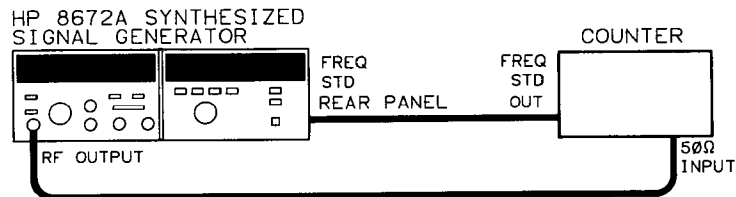

Figure 3-8. Frequency Checks Test Setup

6. Set the Signal Generator as follows:

- | | |
|-----------------------------|-------------------------|
| RF OUTPUT | OFF |
| PEAK-NORM control | NORM (in detent) |
| OUTPUT LEVEL RANGE selector | fully counter-clockwise |
| OUTPUT LEVEL VERNIER | fully counter-clockwise |
| ALC selector | INT |
| ALC CAL control | fully clockwise |

7. Press the HOLD key. Verify that the Signal Generator's displays indicate the following conditions:

- | | |
|------------------------------|---|
| RANGE dB display | -110 dB |
| Meter | <-10 dBm |
| ALC annunciator | INT and UNLVL |
| RF annunciator | OFF |
| FREQUENCY MHz display | some frequency between 2.0 and 18.599997 GHz. If the display is not stable, press the PRESET (3 GHz) key. |
| FREQUENCY RESOLUTION display | All four segments extinguished. |

STATUS annunciators:

- | | |
|------------------------|---|
| OVEN COLD | may be on but should extinguish within 15 minutes after line cord is connected. |
| φ UNLOCKED annunciator | ON |

All other annunciators should be extinguished.

OPERATOR'S CHECKS

Basic Functional Checks (cont'd)**Procedure
(cont'd)**

8. Press the PRESET (3 GHz) key and then the 100 MHz FREQUENCY RESOLUTION key. Verify that the leftmost segment in the FREQUENCY RESOLUTION display lights and that the other segments are extinguished.

NOTE

Do not tune above 6199.999 MHz in steps 9 through 17.

9. Verify that the displayed frequency can be tuned in 100 MHz increments using the TUNING knob.
10. Press the 1 MHz FREQUENCY RESOLUTION key. Verify that the two leftmost segments in the FREQUENCY RESOLUTION display are lighted and that the other segments are extinguished.
11. Verify that the displayed frequency can be tuned in 1 MHz increments using the TUNING knob.
12. Press the 10 kHz FREQUENCY RESOLUTION key. Verify that the three leftmost segments in the FREQUENCY RESOLUTION display are lighted and that the other segment is extinguished.
13. Verify that the displayed frequency can be tuned in 10 kHz increments using the TUNING knob.
14. Press the 1 kHz FREQUENCY RESOLUTION key. Verify that all segments in the FREQUENCY RESOLUTION display are lighted.
15. Verify that the displayed frequency can be tuned in 1 kHz increments using the TUNING knob.
16. Tune the frequency to 4 GHz and press the HOLD key. Verify that the four segments of the FREQUENCY RESOLUTION display are extinguished.
17. Press the PRESET (3 GHz) key and verify that the FREQUENCY RESOLUTION display indicates 3000.000 MHz.
18. Set the Signal Generator as follows:
- | | |
|-----------------------------|----------------------------|
| RF OUTPUT | ON |
| PEAK-NORM control | NORM (in detent) |
| OUTPUT LEVEL RANGE selector | 0 dB range |
| OUTPUT LEVEL VERNIER | for 0 dBm reading on meter |
| ALC selector | INT |
| ALC CAL control | fully clockwise |
19. Tune the Signal Generator frequency to 2 GHz and select 1 kHz FREQUENCY RESOLUTION. Slowly tune from 2000.000 MHz to 2000.010 MHz. Verify that the ϕ UNLOCKED annunciator remains off at each step.
20. Set the frequency tuning resolution to the values shown in the following table. For each tuning resolution, slowly tune from the corresponding start frequency to the stop frequency. Each time, verify that the ϕ UNLOCKED annunciator remains off. (Each phase-locked loop is tuned over its entire range.)

OPERATOR'S CHECKS

Basic Functional Checks (cont'd)

Procedure (cont'd)

FREQUENCY RESOLUTION	Start Frequency	Stop Frequency
10 kHz	2000.010 MHz	2001.000 MHz
1 MHz	2001.000 MHz	2100.000 MHz
100 MHz	2100.000 MHz	6200.000 MHz

- Set the frequency to 18599.997 MHz (overrange). Verify that the ϕ UNLOCKED annunciator remains off.

Output Level Check

The Signal Generator's internal output leveling loop (ALC) is checked to ensure that it remains locked at all specified power levels. The internal output leveling loop monitors most of the RF output circuitry. The output level can be monitored with a power meter for greater assurance that the Signal Generator is operating properly.

- Press PRESET (3 GHz). Set the Signal Generator as follows:

RF OUTPUT	ON
PEAK-NORM control	NORM (in detent)
OUTPUT LEVEL RANGE selector	fully counter-clockwise
OUTPUT LEVEL VERNIER	fully counter-clockwise
ALC selector	INT
ALC CAL control	fully clockwise
- Connect a 50 ohm load or attenuator to the Signal Generator's RF OUTPUT connector. This reduces unwanted power reflections back into the RF OUTPUT connector, thus avoiding a false UNLVL annunciator indication.
- Tune the frequency to 6200.000 MHz.
- Using the OUTPUT LEVEL RANGE selector, step the output level range from -110 to +10 dB. Verify that the UNLVL annunciator remains off.
- Set OUTPUT LEVEL RANGE to 0 dBm and sweep the OUTPUT LEVEL VERNIER across its entire range. Verify that the annunciator remains off at all VERNIER settings.
- Select 100 MHz frequency tuning resolution and set the output level to +8 dBm. Tune slowly from 2000.000 MHz to 18000.000 MHz. Verify that the indicated power level on the Signal Generator's meter remains constant and stable and that the UNLVL annunciator remains off. This ensures that the instrument can generate specified output power and remain leveled.

NOTE

Momentary flashing of the UNLVL when tuning is normal. Make sure that it remains off after the meter has settled, at each frequency.

OPERATOR'S CHECKS

Basic Functional Checks (cont'd)

Procedure (cont'd)

AM Check

The Signal Generator's front panel meter and ALC UNLVL status annunciator are used as an indication of AM. The meter monitors input signal level only, rather than actual AM. A spectrum analyzer can be used to monitor the signal at the RF output connector for presence of AM sidebands between 2 and 6.2 GHz only. Measurements above 6.2 GHz using a spectrum analyzer will not be accurate.

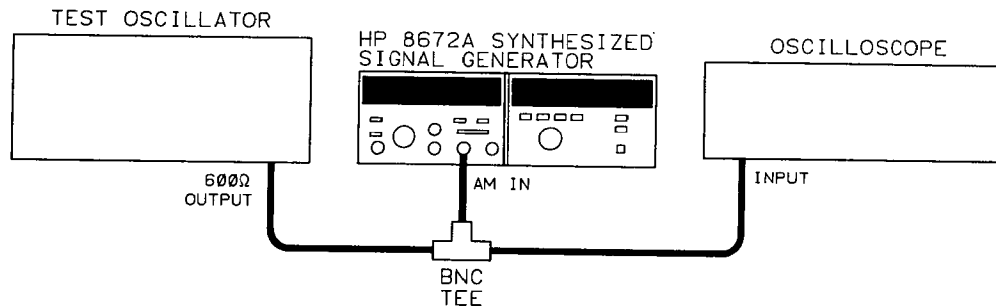

Figure 3-9. AM Check Test Setup

28. Connect the test equipment as shown in Figure 3-9.
29. Press PRESET (3 GHz) to set the Signal Generator to a known state. Set the METER MODE switch to AM.
30. Tune the test oscillator to 10 kHz at 0V.
31. Set the Signal Generator to each setting shown in the table below. For each setting, slowly increase the test oscillator's output level (starting from 0V) while observing the Signal Generator's meter. The meter should indicate a smooth and continuous increase in AM depth. When the meter displays the %AM indicated in the table, verify that the oscilloscope shows the corresponding peak voltage. The ALC UNLVL status annunciator should remain off.

Signal Generator					Oscilloscope Display
FREQUENCY	RANGE	VERNIER	AM Switch	%AM	
2 GHz	0 dB	0 dBm	100%	75	0.75 V _{peak}
10 GHz	0 dB	0 dBm	100%	60	0.60 V _{peak}
18 GHz	0 dB	0 dBm	100%	50	0.50 V _{peak}

FM Check

The Signal Generator's front panel meter is used to monitor input signal level, which is proportional to FM peak deviation. A spectrum analyzer can be used to monitor the signal at the RF OUTPUT connector for greater assurance of FM performance. The FM OVERMOD status annunciator detects a FM overmodulation condition.

OPERATOR'S CHECKS

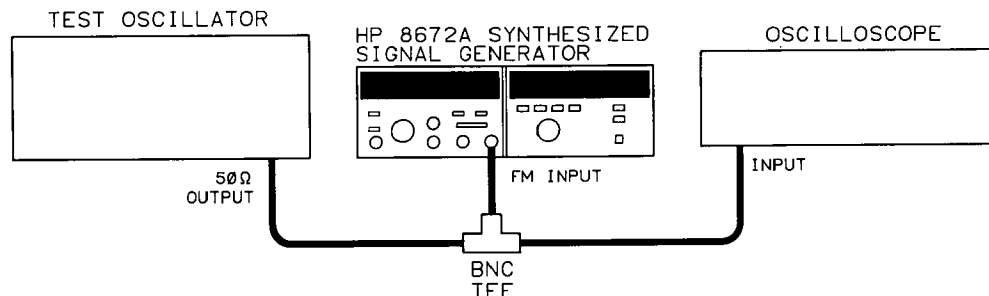
Basic Functional Checks (cont'd)**Procedure (cont'd)****Figure 3-10. FM Check Test Setup**

32. Connect the equipment as shown in Figure 3-10.
33. Press PRESET (3 GHz) to set the Signal Generator to a known state.
34. Set the Signal Generator as shown:
 - OUTPUT LEVEL RANGE 0 dB
 - OUTPUT LEVEL VERNIER ... 0 dBm
 - FM DEVIATION switch 0.03 MHz
 - METER MODE switch FM
35. Tune the test oscillator to 3 MHz at 0V.
36. Slowly increase the output amplitude of the test oscillator (starting from 0V) until the Signal Generator's meter reads full scale. Verify that the meter increases slowly and continuously and that the FM OVERMOD annunciator remains off. Temporary flickering of the FM OVERMOD annunciator is normal for fast changes in peak deviation. The oscilloscope display should indicate approximately 1 V_{peak}.
37. Repeat step 36 for each of the following FM deviation ranges: 0.1, 0.3, 1, 3, and 10 MHz.
38. Set the Signal Generator's FM DEVIATION range to 10 MHz. Increase the test oscillator's output amplitude until a full scale reading is obtained. Decrease the test oscillator's frequency until the Signal Generator's FM OVERMOD annunciator turns on. This should occur at a modulation frequency of 1 to 2 MHz (modulation index of approximately 6.5).



OPERATOR'S CHECKS

3-43. HP-IB Functional Checks

Description These procedures check the Signal Generator's ability to process or send the HP-IB messages described in Table 3-3. Only the Signal Generator, a controller, and an HP-IB controller interface (for the HP-85B) are needed to perform these checks.

These procedures do not check that all the Signal Generator's program codes are being properly executed by the instrument. However, if the Basic Functional Checks and the HP-IB Checks all pass, then the instrument will probably execute all commands.

If the Signal Generator fails any of these HP-IB checks, make sure the controller and interface are working properly.

The select code of the controller's HP-IB interface is assumed to be 7. The address of the Signal Generator is assumed to be 19 (its factory-set address). This particular select code-address combination (that is, 719) is not necessary for these checks to be valid. However, the program lines presented here must be modified for any other combination.

Instructions for changing the address are in Section II, Installation.

These checks can be performed together or separately. Any special requirements for a check are described at the beginning of the check.

Initial Setup The test setup is the same for all of the HP-IB Checks. Connect the the Signal Generator to the controller and set the Signal Generator as follows:

- RF Output switch ON
- PEAK-NORM control NORM (in detent)
- OUTPUT LEVEL RANGE selector fully counter-clockwise
- OUTPUT LEVEL VERNIER fully clockwise
- ALC selector INT
- CAL control fully clockwise
- Frequency 6000.000 MHz

Equipment HP-IB Controller/Interface HP-85B/82937A
 — or —
 HP 9826A Option 011
 (BASIC 2.0 ROM Operating System)
 — or —
 HP 9836A with BASIC 2.0
 Operating System

Remote and Local Message

Note This check determines whether the Signal Generator properly switches from local to remote control and from remote to local control. If the instrument is in remote, switch the LINE switch to STANDBY, then to ON.

OPERATOR'S CHECKS

HP-IB Functional Checks (cont'd)

Description	HP-85B (BASIC)	HP 9826A (BASIC) HP 9836A (BASIC)
Send the Remote message (by setting the Remote Enable bus control line, REN, true and addressing the Signal Generator to listen).	REMOTE 719	REMOTE 719

Operator's Response

Check that the Signal Generator's REMOTE annunciator is on and the OUTPUT LEVEL meter reads -10 dBm.

Send the Local message to the Signal Generator.	LOCAL 719	LOCAL 719
---	-----------	-----------

Operator's Response

Check that the Signal Generator's REMOTE annunciator is off and the OUTPUT LEVEL meter reads +3 dBm.

Receiving the Data Message

Note

This check determines whether the Signal Generator properly receives Data messages.

Description	HP-85B (BASIC)	HP 9826A (BASIC) HP 9836A (BASIC)
Send the first part of the Remote message (enabling the Signal Generator to remote.)	REMOTE 7	REMOTE 7
Address the Signal Generator to listen (completing the Remote message), then send a Data message.	OUTPUT 719; "P18W0Z173075"	OUTPUT 719; "P18W0Z173205"

Operator's Response

Check that the Signal Generator's REMOTE annunciator is on, RANGE dB indicates -70 dB, ALC annunciators show XTAL mode and UNLVL, and the FREQUENCY MHz display shows 18 000 MHz, AM is set to 100% and FM is set to 10 MHz.

Sending the Data Message

Note

This check determines whether the Signal Generator properly issues a Data message when addressed to talk. Before beginning this test, set the LINE switch to OFF, then to ON. (If an HP 9826A or 9836A controller is used, a short program is required to perform this check.)



OPERATOR'S CHECKS

HP-IB Functional Checks (cont'd)

Description	HP-85B (BASIC)	HP 9826A (BASIC) HP 9836A (BASIC)
Send the Remote message.	REMOTE 719	10 REMOTE 719
Send a Data message to set the status byte.	OUTPUT 719; "M070"	20 OUTPUT 719; "M000"
Address the Signal Generator to talk and store its output in variable V.	ENTER 719 using "#,B";V	30 V=0 40 ENTER 719 using "#,B";V
Display the value of V.	DISP V	50 DISP V 60 END

Operator's Response

Check that the Signal Generator's REMOTE annunciator is on. The controller should display 30.

Receiving the Clear Message

Note

This check determines whether the Signal Generator responds properly to the Clear message. This Check assumes that the Signal Generator is in remote mode.

Description	HP-85B (BASIC)	HP 9826A (BASIC) HP 9836A (BASIC)
Send a Data message to initialize the Signal Generator	Output 719; "P18W0Z173075"	Output 719; "P18W0Z173075"

Operator's Response

Check that the Signal Generator is set to 18 000 MHz, XTAL ALC mode, RF OUTPUT ON, AM and FM OFF.

Send the Clear message	CLEAR 719	CLEAR 719
------------------------	-----------	-----------

Operator's Response

Check that the Signal Generator is set to 3000 MHz, INT ALC mode, and RF OUTPUT OFF.

Receiving the Abort Message

Note

This check determines whether the Signal Generator becomes unaddressed when it receives the Abort message. This check assumes the Signal Generator is in remote mode and at a frequency other than 2000 MHz.

OPERATOR'S CHECKS

HP-IB Functional Checks (cont'd)

Description	HP-85B (BASIC)	HP 9826A (BASIC) HP 9836A (BASIC)
Address the Signal Generator to listen and send part of a frequency message. Send the Abort message, unaddressing the Signal Generator from listening. Address the controller to talk. The Signal Generator is not addressed to listen. Attempt to execute the previous frequency command by sending the frequency execute command.	OUTPUT 719; "A2000" ABORTIO 7 SEND 7; MTA OUTPUT 7; "Z1"	OUTPUT 719; "A2000" ABORT 7 SEND 7; MTA OUTPUT 7; "Z1"

Operator's Response

Check that the Signal Generator does not display 2000 MHz output frequency. If the controller is an HP 9826A or 9836A, press the CLR I/O key to continue the checks.

Status Byte Message

Note

This check determines whether the Signal Generator sends the Status Byte message. This check assumes that the Clear message has been sent.

Description	HP-85B (BASIC)	HP 9826A (BASIC) HP 9836A (BASIC)
Send the Serial Poll message to the Signal Generator (causing it to send the Status Byte message). Display the value of the status byte.	SPOLL(719)	SPOLL(719)

Operator's Response

Check that the controller's display reads 28.

Require Service Message

Note

This check determines whether the Signal Generator can issue the Require Service message (set the SRQ bus control line true). This check can be performed in either local or remote mode.

Description	HP-85B (BASIC)	HP 9826A (BASIC) HP 9836A (BASIC)
Send the Clear message Send a Data message containing an out-of-range frequency. This causes the Require Service message to be sent.	CLEAR 719 OUTPUT 719; "P35Z1"	CLEAR 719 OUTPUT 719; "P35Z1"



OPERATOR'S CHECKS

HP-IB Functional Checks (cont'd)

Note If an HP 9826A or 9836A controller is being used, a short program is required for the next part of this check.

Description	HP-85B (BASIC)	HP 9826A (BASIC) HP 9836A (BASIC)
Read the binary status of the controller's HP-IB interface and store the data in variable V. In this step, 7 is the interface's select code, and 2 (HP-85B) and 7 (HP 9826A) are status registers for bus control lines.	STATUS 7,2;V	10 V=0 20 STATUS 7,7; V
Display the value of the SRQ bit. In this step, 5 (HP-85B) and 10 (HP 9826A or HP 9836A) are the SRQ bits for the controller, numbered from 0.	DISP "SRQ="; BIT(V,5)	30 DISP "SRQ =";BIT(V,10) 40 END

Operator's Response Check that the SRQ value is 1, indicating that the Signal Generator issued the Require Service message.

Status Bit Message

Note This check determines whether the Signal Generator sends the Status Bit message. This check can be performed in either local or remote mode. This check assumes that the Clear message has been sent.

Description	HP-85B (BASIC)	HP 9826A (BASIC) HP 9836A (BASIC)
Set up a Service Request condition by programming an illegal frequency.	OUTPUT 719; "P99Z1"	OUTPUT 719; "P99Z1"
Send the parallel poll message to the Signal Generator (causing it to send the Status Bit message).	PPOLL(7)	PPOLL(7)

Operator's Response Check that the controller displays 128, or the value of the bit that parallel poll switch is set to.

SECTION IV PERFORMANCE TESTS

4-1. INTRODUCTION

The procedures in this section test the instrument's electrical performance using the specifications of Table 1-1 as the performance standards. These tests are suitable for incoming inspection, troubleshooting, and preventive maintenance. All tests can be performed without accessing the interior of the instrument. A simpler operational test is included in Section III under Operator's Checks.

4-2. ABBREVIATED PERFORMANCE TEST

In most cases, it is not necessary to perform all of the tests in this section. Tests which should be performed after repairing the Signal Generator or to verify instrument operation appear on succeeding pages under the headings:

- 4-7. FREQUENCY RANGE AND RESOLUTION TEST
- 4-9. OUTPUT LEVEL, HIGH LEVEL ACCURACY AND FLATNESS TEST
- 4-16. EXTERNAL FM ACCURACY AND METER ACCURACY
- 4-22. EXTERNAL AM ACCURACY AND METER ACCURACY

These tests can also be used for incoming inspections and preventative maintenance. They are not intended to be a complete check of specifications, but will provide 90% confidence that the Signal Generator is meeting its major performance specifications. These tests can be performed with less time and equipment than the full Performance Tests.

NOTE

To consider the performance tests valid, the following conditions must be met:

- a. The Signal Generator must have a 1-hour warmup for all specifications.*
- b. The line voltage must be 100, 120, 220, or 240 Vac +5%, -10%.*
- c. The ambient temperature must be +15 to +35°C for the Output Level Flatness and RF Output Level and Accuracy tests; 0 to 55°C for all other tests.*

4-3. CALIBRATION CYCLE

This instrument requires periodic verification of performance to ensure that it is operating within specified tolerances. The performance tests described in this section should be performed at least once each year; under conditions of heavy usage or severe operating environments, the tests should be more frequent. Adjustments that may be required are described in Section V, Adjustments.

4-4. PERFORMANCE TEST RECORD

Results of the performance tests may be tabulated in Table 4-4, Performance Test Record. The Performance Test Record lists all of the performance test specifications and the acceptable limits for each specification. If performance test results are recorded during an incoming inspection of the instrument, they can be used for comparison during periodic maintenance or troubleshooting. The test results may also prove useful in verifying proper adjustments after repairs are made.

4-5. EQUIPMENT REQUIRED

Equipment required for the performance tests is listed in Table 1-3, Recommended Test Equipment. Any equipment that satisfies the critical specifications given in the table may be substituted.

4-6. TEST PROCEDURES

It is assumed that the person performing the following tests understands how to operate the specified test equipment. Equipment settings, other than those for the Signal Generator, are stated in general terms. For example, a test might require that a spectrum analyzer's resolution bandwidth be set to 100 Hz; however, the sweep time would not be specified and the operator would be expected to set that control and other controls as required to obtain an optimum display. It is also assumed that the technician will select the cables, adapters, and probes (listed in Table 1-3) required to complete the test setups illustrated in this section.

PERFORMANCE TESTS

4-7. FREQUENCY RANGE AND RESOLUTION TEST

Specification

Electrical Characteristics	Performance Limits	Conditions
FREQUENCY		
Range	2.0—18.0 GHz (Overrange to 18.599997 GHz)	
Resolution	1 kHz 2 kHz 3 kHz	2.0 to 6.2 GHz 6.2 to 12.4 GHz 12.4 to 18.0 GHz

Description

This test checks the resolution in each of three internal frequency bands using a frequency counter. The performance test is divided into a baseband check (2.0 to 6.2 GHz) and a check for bands 2 and 3 (6.2 to 12.4 GHz and 12.4 to 18.0 GHz respectively).

Equipment

Frequency Counter HP 5343A

Procedure

Baseband Test

1. Connect the equipment as shown in Figure 4-1. Set the Signal Generator rear panel INT/EXT switch to EXT. Remove FREQ STANDARD jumper and connect A3J10 to the 10 MHz frequency standard output of the frequency counter.

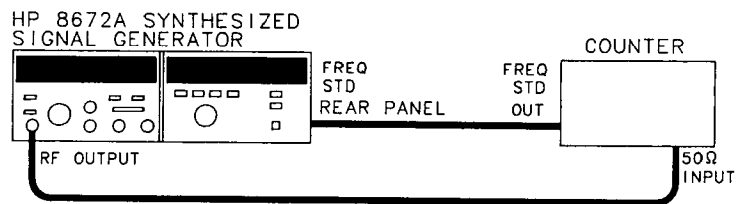

Figure 4-1. Frequency Range and Resolution Test Setup

2. Select 1 kHz display resolution on the counter.
3. Press the Signal Generator's PRESET (3 GHz) key and set the output power to 0 dBm.
4. Verify that the frequency counter reads 3 000.000 MHz ±1 count.

2 999.999 MHz _____ 3 000.001 MHz

5. Tune to each of the frequencies listed below. Verify that the ϕ UNLOCKED annunciator remains off at each frequency and that the frequency counter agrees with the Signal Generator frequency display ±1 count.

PERFORMANCE TESTS

FREQUENCY RANGE AND RESOLUTION TEST (cont'd)

**Procedure
(cont'd)**

Frequency (MHz)	Minimum Frequency (MHz)	Actual Frequency (MHz)	Maximum Frequency (MHz)
2 000.000	1 999.999	_____	2 000.001
2 000.001	2 000.000	_____	2 000.002
2 001.112	2 001.111	_____	2 001.113
2 002.223	2 002.222	_____	2 002.224
2 003.334	2 003.333	_____	2 003.335
2 004.445	2 004.444	_____	2 004.446
2 005.556	2 005.555	_____	2 005.557
2 006.667	2 006.666	_____	2 006.668
2 007.778	2 007.777	_____	2 007.779
2 008.889	2 008.888	_____	2 008.890
2 009.999	2 009.998	_____	2 010.000

6. Tune the Signal Generator to each of the frequencies listed below and read the frequency counter at each step. The frequency counter reading should agree with the Signal Generator front panel reading within ± 1 count. In addition, the Signal Generator ϕ UNLOCKED front panel annunciator should remain off at all frequencies.

NOTE

Fast tuning of frequency may cause the ϕ UNLOCKED annunciator to flash on momentarily. This is normal and does not indicate a malfunction.

Frequency (MHz)	Minimum Frequency (MHz)	Actual Frequency (MHz)	Maximum Frequency (MHz)
2 090.000	2 089.999	_____	2 090.001
2 280.000	2 279.999	_____	2 280.001
2 470.000	2 469.999	_____	2 470.001
2 660.000	2 659.999	_____	2 660.001
2.850.000	2 849.999	_____	2 850.001
3 040.000	3 039.999	_____	3 040.001
3 230.000	3 229.999	_____	3 230.001
3 420.000	3 419.999	_____	3 420.001
3 610.000	3 609.999	_____	3 610.001
3 800.000	3 799.999	_____	3 800.001
3 990.000	3 989.999	_____	3 990.001

(cont'd)

PERFORMANCE TESTS

FREQUENCY RANGE AND RESOLUTION TEST (cont'd)**Procedure
(cont'd)**

Frequency (MHz)	Minimum Frequency (MHz)	Actual Frequency (MHz)	Maximum Frequency (MHz)
4 180.000	4 179.999	_____	4 180.001
4 370.000	4 369.999	_____	4 370.001
4 560.000	4 559.999	_____	4 560.001
4 750.000	4 749.999	_____	4 750.001
4 940.000	4 939.999	_____	4 940.001
5 130.000	5 129.999	_____	5 130.001
5 320.000	5 319.999	_____	5 320.001
5 510.000	5 509.999	_____	5 510.001
5 700.000	5 699.999	_____	5 700.001
5 900.000	5 899.999	_____	5 900.001
6 100.000	6 099.999	_____	6 100.001

Bands 2 and 3 Test

7. Tune the Signal Generator to 10 000.000 MHz and select 1 kHz tuning resolution.
 8. Tune the frequency down one increment and verify that the Signal Generator frequency display changes to 9 999.998 MHz and the frequency counter reading agrees within one count.
 9. Tune the frequency up two increments and verify that the Signal Generator frequency display changes to 10 000.002 MHz. Verify also that the frequency counter reading agrees within one count.
10 GHz frequency resolution, 2 kHz _____ (✓)
 10. Tune the Signal Generator to 18 000.000 MHz and select 1 kHz tuning resolution.
 11. Tune the frequency down one increment and verify that the Signal Generator frequency display indicates 17 999.997 MHz and the frequency counter reading agrees within one count.
 12. Tune the frequency up two increments and verify that the Signal Generator frequency display indicates 18 000.003 MHz and the frequency counter reading agrees within one count.
18 GHz frequency resolution, 3 kHz _____ (✓)
 13. Disconnect the frequency standard cable and replace the **FREQ STANDARD JUMPER** between A3J9 and A3J10. Set the INT/EXT switch to NT.
-

PERFORMANCE TESTS

4-8. FREQUENCY SWITCHING TIME TEST

Specification

Electrical Characteristics	Performance Limits	Conditions
<p>SWITCHING TIME</p> <p>Frequency to be within the specified resolution.</p> <p>Amplitude to be within ± 3 dB of final level after switching frequency.</p>	<p><15 ms</p> <p><15 ms</p>	<p>When switching within the same frequency resolution range.</p>

Description

This test measures the frequency switching speed. The Signal Generator is remotely programmed to continuously switch between two frequencies. Its output is mixed with a local oscillator whose output frequency is set to 1 kHz above the second (or destination) frequency. The difference frequency (IF) is displayed on an oscilloscope.

Frequency switching speed is first measured in the Signal Generator's base band (2.0—6.2 GHz) using an IF frequency of 1 kHz (which is the specified resolution for the base band). As the unit under test is switched from the starting frequency to the destination frequency the oscilloscope is triggered by the HP-IB controller.

As the Signal Generator output changes between the two programmed frequencies the IF signal will pass through zero. This will generate a phase reversal, as shown in Figure 4-3. The last phase change of the IF frequency is the point that the frequency of the unit under test is within the specified resolution.

The amplitude recovery time is tested using the same measurement setup. The ± 3 dB amplitude points of the IF signal are calibrated on the oscilloscope display and the amplitude recovery time is tested to ensure that the IF level is within ± 3 dB of the final level (see Figure 4-4). The amplitude recovery time is only specified for frequency changes within the same frequency resolution range.

NOTE

A digitizing oscilloscope will make this measurement easier due to the ability to store and view the switching process. The test may be performed without a digitizing oscilloscope by repetitively switching the frequency of the unit under test.

Equipment

HP-IB Controller	HP 85B/82903 or HP 9836A
Local Oscillator	HP 8340A
Mixer	RHG DMS1-18
Oscilloscope	HP 1980B

PERFORMANCE TESTS

FREQUENCY SWITCHING TIME TEST (cont'd)**Procedure**

Figure 4-2. Frequency Switching Time Test Setup

Frequency Switching Time

1. Set the equipment as shown in Figure 4-2. The external trigger input of the oscilloscope should be connected to pin 6 of the HP-IB cable. An HP-IB adapter (HP 10834A) can be used to make a permanent adapter for this test. This test may be performed by connecting the external trigger input of the oscilloscope to A2A7TP1. The test results should be identical for both methods of oscilloscope triggering.

WARNING

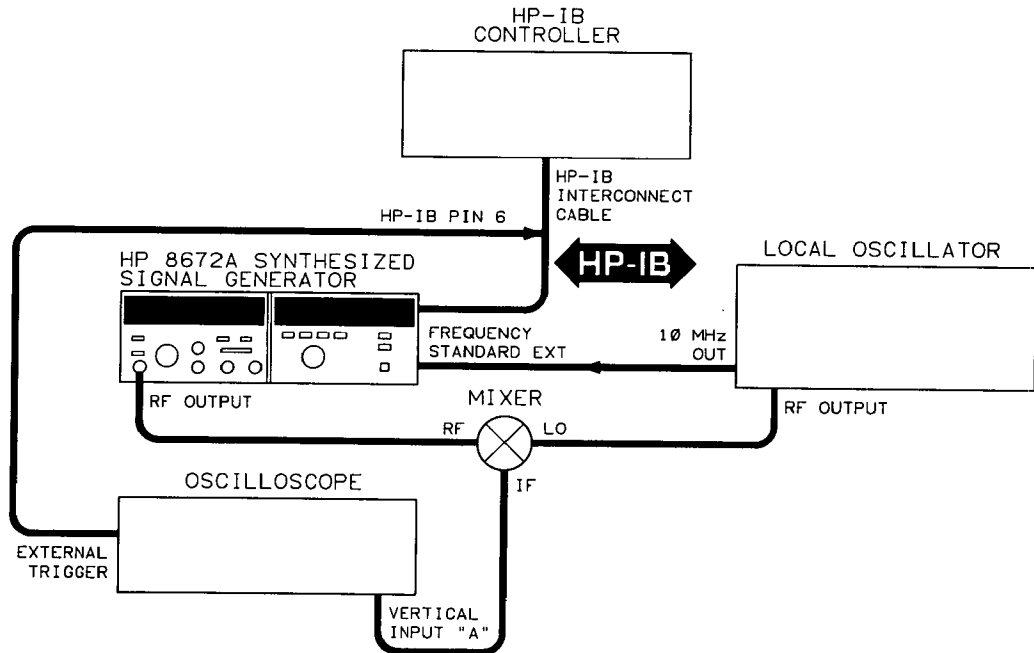
To access A2A7TP1 the instruments protective covers must be removed. This should only be done by service-trained personnel who are aware of the hazards involved (for example, fire and electrical shock).

2. Set the local oscillator to 2 100.001 MHz with an output level between +5 dBm and +8 dBm.
3. Set the oscilloscope to external trigger, positive slope trigger, triggered sweep mode (or NORMAL) and 2 ms per division sweep time.

PERFORMANCE TESTS

FREQUENCY SWITCHING TIME TEST (cont'd)**Procedure
(cont'd)****NOTE**

The following programs are for the HP 9826 or HP 9836 controller. For use with the HP 85B controller, increase the wait statements by a factor of 1000. This is done because the HP 85B executes wait commands in milliseconds while the HP 9836 and HP 9826 execute wait commands in seconds.

4. Load and run the following HP-IB controller program. As the program is executing, adjust the trigger controls for a stable 1 kHz sine wave display.

```

10 CLEAR 719
20 OUTPUT 719; "A2100000Z100075"
30 GOTO 20
40 END

```

5. Press the pause key on the controller to stop the program. Load and run the following program. The program will continue switching the Signal Generator between 18 GHz and 2.1 GHz until the pause key is pressed. If necessary, adjust the oscilloscope triggering to obtain a display similar to that shown in Figure 4-3.

```

10 SEND 7; MTA LISTEN 19
20 OUTPUT 7; "K00075"
30 OUTPUT 7; "P18000000Z1"
40 WAIT .005
50 OUTPUT 7; "A2100000Z"
60 WAIT 7
70 OUTPUT 7; "1"
80 WAIT .05
90 GOTO 30
100 END

```

Controller talk, Signal Generator listen
0 dB range, Ext ALC
Set to 18 GHz
5 for HP 85B (5 ms)
Ready for change to 2.1 GHz
700 for HP 85B (700 ms)
Change frequency
50 for HP 85B (50 ms)

PERFORMANCE TESTS

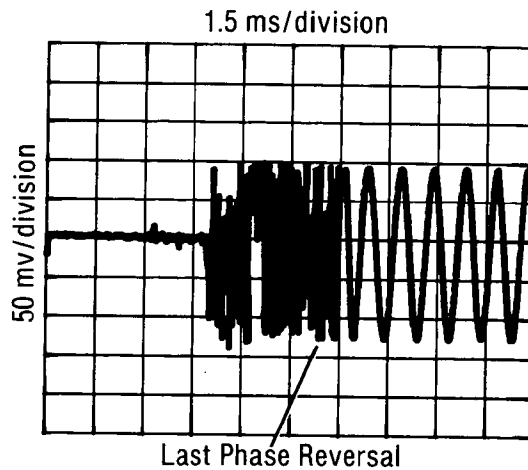
FREQUENCY SWITCHING TIME TEST (cont'd)**Procedure
(cont'd)****Figure 4-3. Frequency Switching Time Measurement Waveform**

6. Measure the switching time by observing the signal on the oscilloscope display. The external trigger is the reference for determining switching speed. The switching time is measured from the display's left graticule to the last phase reversal (as the Signal Generator passes the local oscillator frequency) before the IF signal settles into a steady frequency. Refer to Figure 4-3. Record the frequency switching time.

_____ <15 ms

7. Modify lines 30 and 50 to read as follows:

		_____	Frequency 2.1 GHz
30	OUTPUT 7;	"A2100000Z1"	
		_____	Frequency 18 GHz
50	OUTPUT 7;	"P1800000Z"	

8. Set the local oscillator frequency to 17 999.997 MHz.
9. Run the modified program and measure the switching time to the last phase reversal

_____ <15 ms

Amplitude Recovery Time

10. Set the local oscillator to 6 100.001 MHz.
11. Load and run the following program. Adjust the vertical sensitivity and position of the display until the displayed signal indicates a peak-to-peak change of exactly 2 divisions in amplitude. This calibrates the oscilloscope to ± 3 dB about 0 dBm. The smaller signal represents -3 dBm and the larger signal represents $+3$ dBm.

PERFORMANCE TESTS

FREQUENCY SWITCHING TIME TEST (cont'd)

Procedure (cont'd)

```

10 CLEAR 719
20 OUTPUT 719; "A6100000Z1"
30 FOR X=1 TO 100
40 OUTPUT 719; "K00071"
50 NEXT X
60 FOR Y=1 TO 100
70 OUTPUT 719; "K06071"
80 NEXT Y
90 GOTO 30
100 END
    
```

12. Set the top of the displayed signal to a convenient reference near the center of the display. Note the two levels for reference. The measurement will be determined by the time required before the amplitude of the IF signal stays between these two levels.
13. Press the pause key on the controller. Enter and run the following program. Run the program by typing RUN 110 and pressing the EXECUTE key (END LINE for the HP 85).

```

110 OUTPUT 719; "A2000000Z103071"
120 SEND 7; "MTA LISTEN 19"
130 OUTPUT 7; "A2100000Z1"
140 WAIT .005
150 OUTPUT 7; "A6100000Z1"
160 WAIT .7
170 OUTPUT 7; "1"
180 WAIT .05
190 GOTO 130
200 END
    
```

14. Measure the amplitude recovery time. The measurement is the time from the left graticule of the display to the last time the IF signal amplitude is outside of the reference points noted in step 13. If necessary, adjust the oscilloscope triggering to obtain a display similar to that shown in Figure 4-4.

_____ <15 ms
 (Record Results for Step 17) _____ <15 ms
 (Record Results for Step 20) _____ <15 ms

PERFORMANCE TESTS

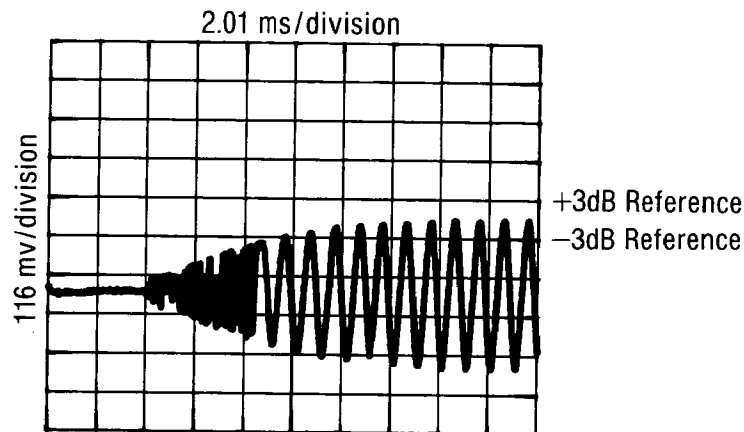
FREQUENCY SWITCHING TIME TEST (cont'd)**Procedure
(cont'd)****Figure 4-4. Amplitude Recovery Measurement Waveform**

15. Set the local oscillator to 12 300.002 MHz.
16. Modify lines 20, 130, and 150 of the program as follows:

20	OUTPUT 719;	"P12300000Z1"	Frequency 12.3 GHz
130	OUTPUT 7;	"A6200000Z1"	Frequency 6.2 GHz
150	OUTPUT 7;	"P12300000Z"	Frequency 12.3 GHz
17. Repeat steps 11 through 14 using the modified programs. The amplitude recovery time will be measured for the 2 kHz resolution band.
18. Set the local oscillator to 18 000.003 MHz.
19. Modify lines 20, 130, and 150 of the program as follows:

20	OUTPUT 719;	"P18000000Z1"	Frequency 18.0 GHz
130	OUTPUT 7;	"A12400000Z1"	Frequency 12.4 GHz
150	OUTPUT 7;	"P18000000Z"	Frequency 18.0 GHz
20. Repeat steps 11 through 14 using the modified program. The amplitude recovery time will be measured for the 3 kHz resolution band.
21. Disconnect the frequency reference from the rear panel and replace the jumper. Set the switch to INT.

PERFORMANCE TESTS

4-9. OUTPUT LEVEL, HIGH LEVEL ACCURACY AND FLATNESS TEST

Specification

Electrical Characteristics	Performance Limits	Conditions
RF OUTPUT		
Output Level: Leveled Output	+8 dBm to -120 dBm ¹	+15 to +35°C
Remote Programming		2.0–6.2 GHz
Absolute Level Accuracy (+15°C to +35°C)	±1.00 dB	+10 dB output level range
	±1.00 dB	0 dB output level range
	±1.50 dB	-10 dB output level range
	±1.70 dB	-20 dB output level range
		6.2–12.4 GHz
	±1.25 dB	+10 dB output level range
	±1.25 dB	0 dB output level range
	±1.75 dB	-10 dB output level range
	±1.95 dB	-20 dB output level range
		12.4–18.0 GHz
	±1.50 dB	+10 dB output level range
	±1.50 dB	0 dB output level range
	±2.10 dB	-10 dB output level range
	±2.30 dB	-20 dB output level range
Manual Absolute Level Accuracy	Add ±0.75 dB to remote programming absolute level accuracy	Absolute level accuracy specifications include allowances for detector linearity, temperature, flatness, attenuator accuracy, and measurement uncertainty.
Flatness (0 dBm range; +15°C to +35°C)	1.50 dB	2.0 to 6.2 GHz
	2.00 dB	2.0 to 12.4 GHz
	2.50 dB	2.0 to 18.0 GHz

Description

This test checks output level (maximum leveled power), absolute level accuracy between +8 dBm¹ and -20 dBm, and output level flatness. The output level test uses a power meter to verify that +8 dBm¹ can be generated over the full 2 to 18 GHz frequency range. Level flatness measures the variation in level over the various specified ranges. The high level accuracy test verifies that power levels between +8 dBm¹ and -20 dBm are within the manual absolute level accuracy specification.

Equipment

Power MeterHP 436A
Power SensorHP 8481A

Procedure

Output Level Test

1. Connect the power sensor to the power meter. Calibrate and zero the power meter.
2. Connect the power sensor to the RF OUTPUT connector of the Signal Generator as shown in Figure 4-5.

¹ For serial number prefixes of 2640A and below (except Option 008), the Performance Limits are +3 dBm to -120 dBm.

PERFORMANCE TESTS

OUTPUT LEVEL, HIGH LEVEL ACCURACY AND FLATNESS TEST (cont'd)

Procedure (cont'd)

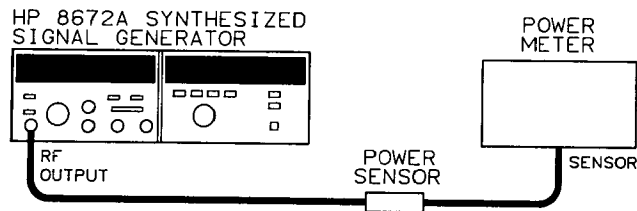

Figure 4-5. Output Level, High Level Accuracy and Flatness Test Setup

3. Set the Signal Generator frequency to 2.0 GHz and the output level range to +10 dB.
4. Adjust the VERNIER control to give a power meter reading of +8 dBm¹.
5. Tune the Signal Generator in 100 MHz steps from 2 to 18 GHz, adjusting the power meter's calibration factor and recording the frequency at which minimum power occurs. Reset VERNIER to read +8 dBm¹ on the power meter at the recorded frequency to ensure that the +8 dBm¹ power level can be met.

Frequency _____
 Minimum Power >+8 dBm (or +3 dBm)¹ _____

Level Flatness

6. Set the Signal Generator frequency to 2 GHz, output level to -5 dBm, and power meter to dB Relative. Slowly tune to 6.2 GHz in 100 MHz steps and record the maximum and minimum relative power outputs. Set the power meter calibration factor appropriate for each frequency. Maximum variation should be within 1.5 dB (highest point to lowest point). Continue to tune to 12.4 GHz. Maximum variation should be within 2 dB. Continue to tune to 18.0 GHz and note level variation. Maximum variation should be less than 2.5 dB.

NOTE

The specification for power output flatness is not referenced to a particular frequency. The specification represents the total power variation over the entire frequency range.

2.0—6.2 GHz	Minimum _____	
	Maximum _____	
	Total Variation _____	<1.50 dB
2.0—12.4 GHz	Minimum _____	
	Maximum _____	
	Total Variation _____	<2.00 dB
2.0—18.0 GHz	Minimum _____	
	Maximum _____	
	Total Variation _____	<2.50 dB

¹For serial number prefixes of 2640A and below (except Option 008), the maximum leveled and calibrated output power is +3 dBm.

PERFORMANCE TESTS

OUTPUT LEVEL, HIGH LEVEL ACCURACY AND FLATNESS TEST (cont'd)**Procedure
(cont'd)****High Level Accuracy Test****NOTE**

Omit steps 7 through 11 for instruments with serial number prefixes of 2640A and below (except Option 008). For instruments with these serial number prefixes the maximum leveled and calibrated output power is +3 dBm.

7. Connect the power sensor to the power meter. Calibrate and zero the power meter in the dBm mode.
8. Connect the power sensor to the RF OUTPUT connector of the Signal Generator.
9. Set the Signal Generator frequency to 2.0 GHz and output level to +8 dBm (+10 dB range and -2 dBm front panel meter setting).
10. Tune the Signal Generator in 2 GHz steps from 2 to 18 GHz. Set the power meter's calibration factor appropriately and record the power output at each frequency in Table 4-1. The power meter readings should be within the limits specified.
11. Repeat steps 9 and 10 for an output level of +3 dBm (+10 dB range, -7 dBm VERNIER).
12. Set the Signal Generator frequency to 2.0 GHz and output level to 0 dBm (0 dB range, 0 dBm VERNIER).
13. Tune the Signal Generator in 2 GHz steps from 2 to 18 GHz. Set the power meter's calibration factor appropriately and record the power output at each frequency in Table 4-1. The power meter readings should be within the limits specified.
14. Repeat steps 12 and 13 for output levels of -5 dBm and -10 dBm (0 dB range).
15. Set the Signal Generator frequency to 2.0 GHz and output level to -10 dBm (-10 dB range, 0 dBm VERNIER).
16. Tune the Signal Generator in 2 GHz steps from 2 to 18 GHz. Set the power meter's calibration factor appropriately and record the power output at each frequency in Table 4-1. The power meter readings should be within the limits specified.
17. Repeat steps 15 and 16 for an output level of -20 dBm (-20 dB range, 0 dBm vernier).

Table 4-1. Output Level, High Level Accuracy and Flatness Test Record (1 of 2)

Test		Results			
		Min.	Actual	Max.	
High Level Accuracy	+8 dBm (+10 dB range)¹	2 GHz	+6.25 dBm	_____	+9.75 dBm
		4 GHz	+6.25 dBm	_____	+9.75 dBm
		6 GHz	+6.25 dBm	_____	+9.75 dBm
		8 GHz	+6.00 dBm	_____	+10.00 dBm
		10 GHz	+6.00 dBm	_____	+10.00 dBm
		12 GHz	+6.00 dBm	_____	+10.00 dBm
		14 GHz	+5.75 dBm	_____	+10.25 dBm
		16 GHz	+5.75 dBm	_____	+10.25 dBm
		18 GHz	+5.75 dBm	_____	+10.25 dBm
	+3 dBm (+10 dB range)	2 GHz	+1.25 dBm	_____	+4.75 dBm
		4 GHz	+1.25 dBm	_____	+4.75 dBm
		6 GHz	+1.25 dBm	_____	+4.75 dBm
		8 GHz	+1.00 dBm	_____	+5.00 dBm
		10 GHz	+1.00 dBm	_____	+5.00 dBm
		12 GHz	+1.00 dBm	_____	+5.00 dBm
		14 GHz	+0.75 dBm	_____	+5.25 dBm
		16 GHz	+0.75 dBm	_____	+5.25 dBm
		18 GHz	+0.75 dBm	_____	+5.25 dBm
0 dBm (0 dB range)	2 GHz	-1.75 dBm	_____	+1.75 dBm	
	4 GHz	-1.75 dBm	_____	+1.75 dBm	
	6 GHz	-1.75 dBm	_____	+1.75 dBm	
	8 GHz	-2.00 dBm	_____	+2.00 dBm	
	10 GHz	-2.00 dBm	_____	+2.00 dBm	
	12 GHz	-2.00 dBm	_____	+2.00 dBm	
	14 GHz	-2.25 dBm	_____	+2.25 dBm	
	16 GHz	-2.25 dBm	_____	+2.25 dBm	
	18 GHz	-2.25 dBm	_____	+2.25 dBm	
-5 dBm (0 dB range)	2 GHz	-6.75 dBm	_____	-3.25 dBm	
	4 GHz	-6.75 dBm	_____	-3.25 dBm	
	6 GHz	-6.75 dBm	_____	-3.25 dBm	
	8 GHz	-7.00 dBm	_____	-3.00 dBm	
	10 GHz	-7.00 dBm	_____	-3.00 dBm	
	12 GHz	-7.00 dBm	_____	-3.00 dBm	
	14 GHz	-7.25 dBm	_____	-2.75 dBm	
	16 GHz	-7.25 dBm	_____	-2.75 dBm	
	18 GHz	-7.25 dBm	_____	-2.75 dBm	
-10 dBm (0 dB range)	2 GHz	-11.75 dBm	_____	-8.25 dBm	
	4 GHz	-11.75 dBm	_____	-8.25 dBm	
	6 GHz	-11.75 dBm	_____	-8.25 dBm	
	8 GHz	-12.00 dBm	_____	-8.00 dBm	
	10 GHz	-12.00 dBm	_____	-8.00 dBm	

¹ For serial number prefixes of 2640A and below (except Option 008), omit the High Level Accuracy check at +8 dBm. The maximum leveled and calibrated output power is +3 dBm.

Table 4-1. Output Level, High Level Accuracy and Flatness Test Record (2 of 2)

Test		Results		
		Min.	Actual	Max.
High Level Accuracy (cont'd)				
-10 dBm (0 dB range) (cont'd)	12 GHz	-12.00 dBm	_____	-8.00 dBm
	14 GHz	-12.25 dBm	_____	-7.75 dBm
	16 GHz	-12.25 dBm	_____	-7.75 dBm
	18 GHz	-12.25 dBm	_____	-7.75 dBm
-10 dBm (-10 dB range)	2 GHz	-12.25 dBm	_____	-7.75 dBm
	4 GHz	-12.25 dBm	_____	-7.75 dBm
	6 GHz	-12.25 dBm	_____	-7.75 dBm
	8 GHz	-12.50 dBm	_____	-7.50 dBm
	10 GHz	-12.50 dBm	_____	-7.50 dBm
	12 GHz	-12.50 dBm	_____	-7.50 dBm
	14 GHz	-12.85 dBm	_____	-7.15 dBm
	16 GHz	-12.85 dBm	_____	-7.15 dBm
	18 GHz	-12.85 dBm	_____	-7.15 dBm
	-20 dBm (-20 dB range)	2 GHz	-22.45 dBm	_____
4 GHz		-22.45 dBm	_____	-17.55 dBm
6 GHz		-22.45 dBm	_____	-17.55 dBm
8 GHz		-22.70 dBm	_____	-17.30 dBm
10 GHz		-22.70 dBm	_____	-17.30 dBm
12 GHz		-22.70 dBm	_____	-17.30 dBm
14 GHz		-23.05 dBm	_____	-16.95 dBm
16 GHz		-23.05 dBm	_____	-16.95 dBm
18 GHz		-23.05 dBm	_____	-16.95 dBm

PERFORMANCE TESTS

4-10. LOW LEVEL ACCURACY TEST

Specification

Electrical Characteristics	Performance Limits	Conditions
<p>RF OUTPUT</p> <p>Remote Programming Absolute Level Accuracy (+15 to +35°C)</p>	<p>±1.90 dB ±1.90 dB plus ±0.3 dB per 10 dB step</p> <p>±2.15 dB ±2.15 dB plus ±0.3 dB per 10 dB step</p> <p>±2.40 ±2.40 dB plus ±0.4 dB per 10 dB step</p>	<p>2.0–6.2 GHz –30 dB output level range <–30 dB output level range</p> <p>6.2–12.4 GHz –30 dB output level range <–30 dB output level range</p> <p>12.4–18.0 GHz –30 dB output level range <–30 dB output level range</p>
<p>Manual Absolute Level Accuracy</p>	<p>Add ±0.75 dB to remote pro- gramming absolute level accuracy</p>	<p>Absolute level accuracy specifications include allowances for detector lin earity, temperature, flatness, attenuator accuracy and measurement uncertainty.</p>

Description

This test checks absolute level accuracy between –30 dBm and –110 dBm. An IF signal is calibrated to the spectrum analyzer by measuring the Signal Generator’s RF output at –20 dBm. A reference level corresponding to the –20 dBm output is set on the spectrum analyzer and each 10 dB decrease in range is checked for a 10 dB decrease on the spectrum analyzer display.

Equipment

- Power Meter HP 436A
- Power Sensor HP 8481A
- Local Oscillator HP 8340A
- Mixer RHG DMS 1-18
- Spectrum Analyzer HP 8566B
- 40 dB Amplifier HP 8447F
- 20 dB Attenuator HP 8491B Option 020
- 20 dB Preamplifier HP 8447A

Procedure

1. Calibrate and zero the power meter in the dBm mode.
2. Connect the equipment as shown in Figure 4-6.

NOTE

Connect the mixer directly to the local oscillator to avoid any power loss.

PERFORMANCE TESTS

LOW LEVEL ACCURACY TEST (cont'd)

Procedure
(cont'd)

Figure 4-6. Low Level Accuracy Test Setup

3. Set the Signal Generator frequency to 2 000.000 MHz, RANGE to -20 dB, and set the VERNIER for 0 dBm.
4. Adjust the VERNIER for a power meter reading of -20.00 dBm ± 0.01 dB.
5. Disconnect the power meter and connect the Signal Generator to the mixer as shown in Figure 4-6.
6. Set the local oscillator to 2 000.100 MHz and output power to maximum but not greater than $+8$ dBm.
7. Set the resolution bandwidth on the spectrum analyzer to 300 Hz or less. Adjust the reference level so that the amplitude of the 100 kHz IF signal is set to a convenient horizontal graticule as a reference. This calibrates the graticule line for an absolute reference power level of -20 dBm. Enable the Delta Marker function on the spectrum analyzer, if available, for highest accuracy.
8. Set the range of the Signal Generator 10 dB lower and adjust the Signal Generator's VERNIER for a front panel meter reading of 0 dBm.
9. Set the spectrum analyzer reference level 10 dB lower to bring the signal level near the reference graticule line.

PERFORMANCE TESTS

LOW LEVEL ACCURACY TEST (cont'd)**Procedure
(cont'd)**

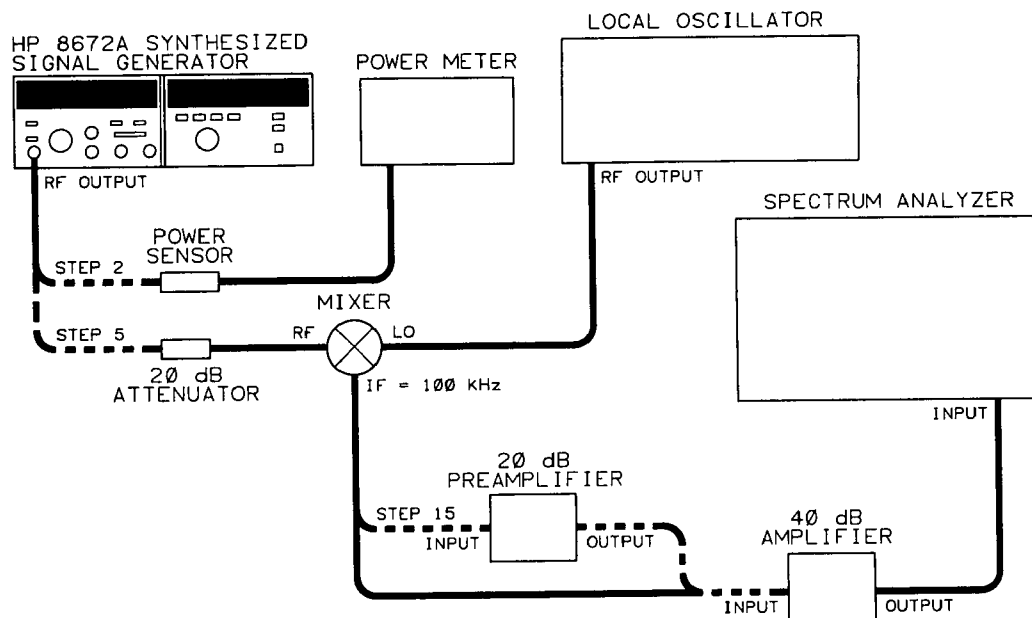
10. Read the difference between the displayed level and the reference graticule. Calculate the actual power as follows:

NOTE

The difference is positive if the signal is above the reference graticule line, and negative if below.

$$\begin{array}{r} \text{—————} \text{ Output level set in step 8.} \\ + \text{—————} \text{ Difference measured in step 10.} \\ \text{—————} \text{ Actual level.} \end{array}$$

Record the actual level calculated in Table 4-2. The level reading should be within the limits specified.

11. Repeat steps 8 through 10, with Signal Generator range settings of -40 dB and -50 dB in step 8. Record the output level readings in Table 4-2.
12. Note the Signal Generator's signal level (at -50 dBm) on the spectrum analyzer display. Remove the 20 dB attenuator, set the spectrum analyzer reference level 20 dB higher, and adjust the spectrum analyzer to bring the peak of the IF signal back to the same reference level.
13. Repeat steps 8 through 10 with Signal Generator settings of -60 dB through -90 dB. Record the output level readings in Table 4-2.
14. Note the Signal Generator's level (at -90 dBm) on the spectrum analyzer display. This will be the reference in step 15.
15. Connect the 20 dB Preamplifier as shown in Figure 4-6. Set the spectrum analyzer IF sensitivity 20 dB higher, and set the vertical sensitivity to bring the signal back to the reference level noted in step 14.
16. Repeat steps 8 through 10, with Signal Generator range settings of -100 dB and -110 dB. Record the output level readings in Table 4-2.
17. Repeat steps 3 through 16 for Signal Generator frequencies of 10 GHz and 18 GHz. Record the output level readings in Table 4-2.

Table 4-2. Low Level Accuracy Test Record

Test	Results		
	Min.	Actual	Max.
2.0 GHz			
-30 dBm	-32.65 dBm	_____	-27.35 dBm
-40 dBm	-42.95 dBm	_____	-37.05 dBm
-50 dBm	-53.25 dBm	_____	-46.75 dBm
-60 dBm	-63.55 dBm	_____	-56.45 dBm
-70 dBm	-73.85 dBm	_____	-66.15 dBm
-80 dBm	-84.15 dBm	_____	-75.85 dBm
-90 dBm	-94.45 dBm	_____	-85.55 dBm
-100 dBm	-104.75 dBm	_____	-95.25 dBm
-110 dBm	-115.05 dBm	_____	-104.95 dBm
10.0 GHz			
-30 dBm	-32.90 dBm	_____	-27.10 dBm
-40 dBm	-43.20 dBm	_____	-36.80 dBm
-50 dBm	-53.50 dBm	_____	-46.50 dBm
-60 dBm	-63.80 dBm	_____	-56.20 dBm
-70 dBm	-74.10 dBm	_____	-65.90 dBm
-80 dBm	-84.40 dBm	_____	-75.60 dBm
-90 dBm	-94.70 dBm	_____	-85.30 dBm
-100 dBm	-105.00 dBm	_____	-95.00 dBm
-110 dBm	-105.30 dBm	_____	-104.70 dBm
18.0 GHz			
-30 dBm	-33.45 dBm	_____	-26.55 dBm
-40 dBm	-43.85 dBm	_____	-36.15 dBm
-50 dBm	-54.25 dBm	_____	-45.75 dBm
-60 dBm	-64.65 dBm	_____	-55.35 dBm
-70 dBm	-75.05 dBm	_____	-64.95 dBm
-80 dBm	-85.45 dBm	_____	-74.55 dBm
-90 dBm	-95.95 dBm	_____	-84.15 dBm
-100 dBm	-106.35 dBm	_____	-93.75 dBm
-110 dBm	-107.75 dBm	_____	-103.35 dBm

PERFORMANCE TESTS

4-11. OUTPUT LEVEL SWITCHING TIME TEST

Specification Less than 20 ms to be within ± 1 dB of the final level.

Description This test measures the output level switching speed. The measuring system is set up to trigger the oscilloscope when the unit under test has finished accepting the output level data from the controller. The RF output is detected and coupled to the oscilloscope's vertical input. The time to complete switching (which includes settling time) is viewed on the oscilloscope display.

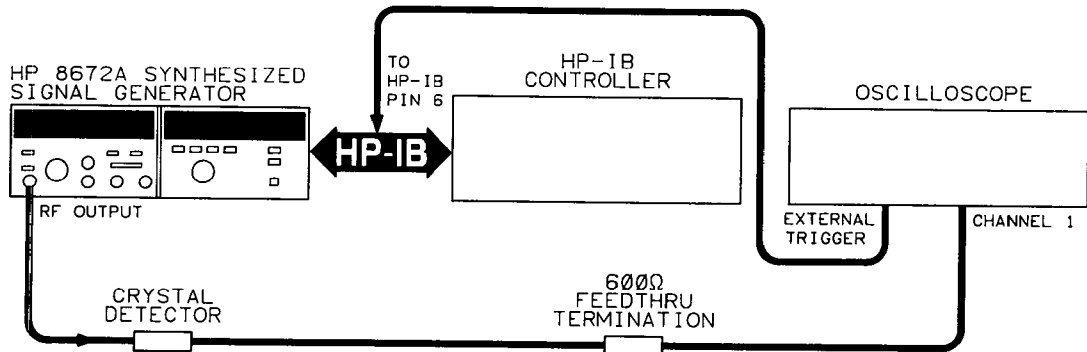

Figure 4-7. Output Level Switching Time Test Setup

Equipment	Oscilloscope	HP 1980B
	HP-IB Controller	HP 9836A or HP 85B/82903
	Crystal Detector	HP 8470B Opt. 012
	600 Ω Feedthru Termination	HP 11095A

- Procedure**
1. Set up the equipment as shown in Figure 4-7. The external trigger input of the oscilloscope should be connected to pin 6 of the HP-IB cable or A2A9U14, pin 15. An HP-IB adapter (HP 10834A) can be used to make a permanent trigger adapter for this test.

WARNING

To access A2A9U14 the instrument's protective cover must be removed. This should be performed only by service-trained personnel who are aware of the hazards involved (for example, fire and electrical shock).

PERFORMANCE TESTS

OUTPUT LEVEL SWITCHING TIME TEST (cont'd)**Procedure
(cont'd)**

2. Set the oscilloscope for external triggering, positive trigger slope, triggered sweep mode (or NORM) and 2 ms per division sweep time.

NOTE

The following programs are for the HP 9826 or HP 9836 controller. For use with the HP 85B controller, increase the wait statements by a factor of 1000. This is necessary because the HP 9826 and HP 9836 execute wait commands in seconds while the HP 85B executes wait commands in milliseconds.

3. Load and run the following HP-IB controller program. As the program is executing, adjust the trigger controls for a stable oscilloscope display.

```

10 CLEAR 719
20 OUTPUT 719; "A3000000Z103075"
30 GOTO 20
40 END

```

3.0 GHz, +3 dBm, Ext ALC

4. Press the pause key on the controller. Load the following HP-IB controller program.

```

10 SEND 7; "MTA LISTEN 19"
20 FOR X=1 TO 50
30 OUTPUT 7; "K0"
40 WAIT .03
50 OUTPUT 7; "K"
60 WAIT .7
70 OUTPUT 7; "K"
80 WAIT .05
90 NEXT X
100 END

```

Controller talk, Signal Generator listen

0 dB range, Ext ALC

30 for HP 85B (30 ms)

Ready for change to -110 dB range

700 for HP 85B (700 ms)

Change to -110 dB range

50 for HP 85B (50 ms)

PERFORMANCE TESTS

OUTPUT LEVEL SWITCHING TIME TEST (cont'd)

**Procedure
(cont'd)**

NOTE

Run this program only as long as necessary to make the level switching measurements. This measurement cycles the attenuator which causes mechanical wear. The program limits the number of cycles to 50, however, if a digitizing oscilloscope is available only one cycle is needed.

- 5. Run the program and measure the switching time by observing the signal on the oscilloscope display. Refer to Figure 4-8.

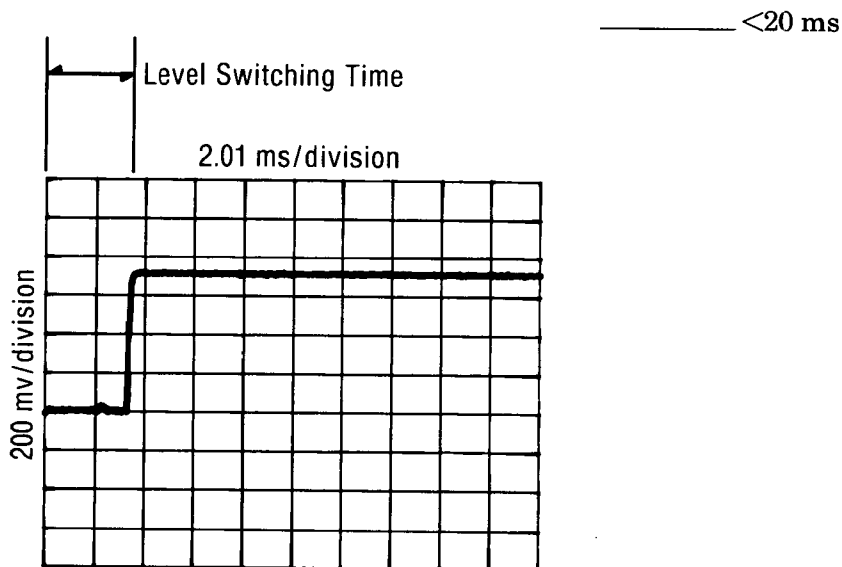

Figure 4-8. Output Level Switching Time Measurement Waveform

PERFORMANCE TESTS

4-12. HARMONICS, SUBHARMONICS, & MULTIPLES TEST

Specification

Electrical Characteristics	Performance Limits	Conditions
SPECTRAL PURITY Harmonics Subharmonics and Multiples Thereof	<-25 dBc <-25 dBc	Output level +8 dBm Output level +8 dBm

Description

This test checks the amplitude of various harmonics of the Signal Generator's output signal. In the multiplied frequency bands (>6.2 GHz), subharmonics and multiples (harmonics of the internal fundamental signal) are also checked for specific levels. Reasonable care must be taken to ensure that the harmonics are not being generated by the spectrum analyzer.

Equipment

Spectrum AnalyzerHP 8566B

Procedure

1. Connect the Signal Generator RF OUTPUT to the input of the spectrum analyzer as shown in Figure 4-9.

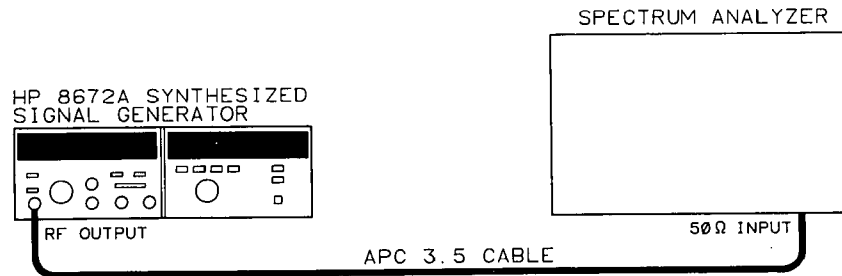

Figure 4-9. Harmonics, Subharmonics, and Multiples Test Setup

2. Tune the Signal Generator to 4 000.000 MHz and output level of +8 dBm.
 3. Set the spectrum analyzer controls to display the fundamental signal. Set the resolution bandwidth to 10 kHz and the input attenuation to 40 dB. Adjust the log reference level to set the displayed signal at the top graticule line of the display.
 4. Tune the Signal Generator to 2 000.000 MHz. The second harmonic, now displayed at 4 000.000 MHz, should be greater than 25 dB below the reference.
- _____ <-25 dBc
5. Repeat steps 2 through 4, at the other Signal Generator frequencies listed, to check each harmonic, subharmonic, and multiple listed in the following table. Record the measurements in Table 4-3.

PERFORMANCE TESTS

HARMONICS, SUBHARMONICS, & MULTIPLES TEST (cont'd)

**Procedure
(cont'd)**

NOTE

This procedure may be repeated for any fundamental frequency of interest within the Signal Generator frequency range.

Harmonics, Subharmonics, and Multiples

Set Signal Generator to	Check Harmonic Levels at:			
FUNDAMENTAL	HARMONIC	SUBHARMONIC		MULTIPLE
(GHz)	(GHz)	1/3	1/2	2/3
2.000 000	4.000 000			
4.000 000	8.000 000			
6.000 000	12.000 000			
8.000 000	16.000 000		4.000 000	
10.000 000	20.000 000		5.000 000	
11.000 000	22.000 000		5.500 000	
14.000 000		4.666 667		9.333 333
16.000 000		5.333 333		10.666 667
18.000 000		6.000 000		12.000 000
LIMITS	<-25 dBc	-25 dBc		

Table 4-3. Harmonics, Subharmonics & Multiples Test Record

Test		Results		
		Min.	Actual	Max.
Fundamental	Harmonic or Subharmonic			
2.000 000 GHz	4.000 000 GHz 2f		_____	-25 dBc
4.000 000 GHz	8.000 000 GHz 2f		_____	-25 dBc
6.000 000 GHz	12.000 000 GHz 2f		_____	-25 dBc
8.000 000 GHz	16.000 000 GHz 2f		_____	-25 dBc
8.000 000 GHz	4.000 000 GHz 1/2f		_____	-25 dBc
10.000 000 GHz	20.000 000 GHz 2f		_____	-25 dBc
10.000 000 GHz	5.000 000 GHz 1/2f		_____	-25 dBc
11.000 000 GHz	22.000 000 GHz 2f		_____	-25 dBc
11.000 000 GHz	5.000 000 GHz 1/2f		_____	-25 dBc
14.000 000 GHz	4.666 667 GHz 1/3f		_____	-25 dBc
14.000 000 GHz	9.33 3333 GHz 2/3f		_____	-25 dBc
16.000 000 GHz	5.333 333 GHz 1/3f		_____	-25 dBc
16.000 000 GHz	10.666 667 GHz 2/3f		_____	-25 dBc
18.000 000 GHz	6.000 000 GHz 1/3f		_____	-25 dBc
18.000 000 GHz	12.000 000 GHz 2/3f		_____	-25 dBc

PERFORMANCE TESTS

4-13. NON-HARMONICALLY RELATED SPURIOUS SIGNALS TEST

Specification

Electrical Characteristics	Performance Limits	Conditions
SPECTRAL PURITY Spurious Non-Harmonically Related	<-70 dBc <-64 dBc <-60 dBc	2.0 to 6.2 GHz 6.2 to 12.4 GHz 12.4 to 18.0 GHz

Description

This test checks for any spurious signals in the Signal Generator's RF output signal. The spectrum analyzer is calibrated for a reference level of -50 dBc and is tuned to any frequency from 2.0 to 6.2 GHz in search of spurious signals.

NOTE

The non-harmonically related spurious signals will always increase in amplitude above 6.2 GHz, due to multiplication in the internal YIG tuned multiplier. The increase is determined by a strict mathematical relationship. Therefore, satisfactory performance in the 2 to 6.2 GHz range will always ensure meeting the less stringent specification in the multiplied ranges, that is, from 6.2 to 18.0 GHz.

Equipment

Spectrum Analyzer HP 8566B

Procedure

1. Connect the Signal Generator's RF OUTPUT to the input of the spectrum analyzer as shown in Figure 4-10.

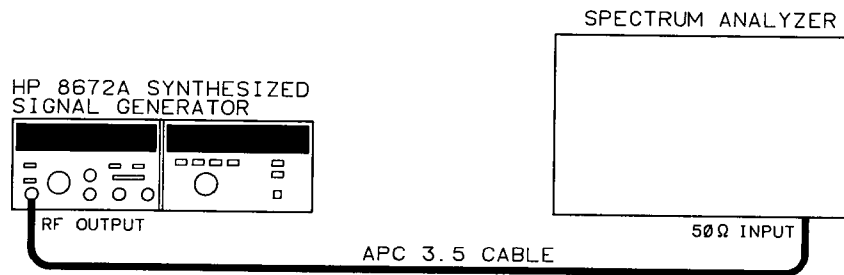

Figure 4-10. Non-Harmonically Related Spurious Signals Test Setup

2. Tune the Signal Generator to 3 000.000 MHz and set the output level to -50 dBm.
3. Set the spectrum analyzer controls to display the fundamental signal. Set the resolution bandwidth to 1 kHz and the frequency span per division to 10 kHz.
4. Set the spectrum analyzer controls so that the carrier signal is at the top graticule line.

PERFORMANCE TESTS

NON-HARMONICALLY RELATED SPURIOUS SIGNALS TEST (cont'd)

Procedure (cont'd)

- 5. Using the RANGE selector, increase the Signal Generator's output level to 0 dBm. Do not adjust the spectrum analyzer amplitude calibration. The top graticule line now represents -50 dBc.
- 6. Tune the spectrum analyzer to any desired frequency in search of non-harmonically related spurious signals. Verify that any signals found are non-harmonically related and are not generated by the spectrum analyzer. Verify that the spurious signals are below the specified limits. Record the results.

Carrier Frequency	Spurious Signal Frequency	Spurious Signal Level
3 000 MHz	_____	_____
3 000 MHz	_____	_____

- 7. Repeat step 2 through 6 for any desired carrier frequency from 2 000.000 to 6 199.999 MHz. Record the results. (Checking non-harmonically related spurious signals from 2.0 to 6.2 GHz provides a high level of confidence that the instrument meets its published specifications from 2 to 18 GHz.)

Carrier Frequency	Spurious Signal Frequency	Spurious Signal Level
_____	_____	_____
_____	_____	_____
_____	_____	_____
_____	_____	_____

PERFORMANCE TESTS

4-14. POWER LINE RELATED SPURIOUS SIGNALS TEST

Specification

Electrical Characteristics	Performance Limits	Conditions
<p>SPECTRAL PURITY Power line related and fan rotation related within 5 Hz below line frequencies and multiples thereof</p>	<p>-50 dBc -60 dBc -65 dBc -44 dBc -54 dBc -59 dBc -40 dBc -50 dBc -55 dBc</p>	<p>2.0—6.2 GHz <300 Hz offset from carrier 300 Hz to 1 kHz offset from carrier >1 kHz offset from carrier 6.2—12.4 GHz <300 Hz offset from carrier 300 Hz to 1 kHz offset from carrier >1 kHz offset from carrier 12.4—18.0 GHz <300 Hz offset from carrier 300 Hz to 1 kHz offset from carrier >1 kHz offset from carrier</p>

Description

The Unit Under Test and local oscillator are isolated from vibration by placing the instruments on two-inch thick foam pads. This eliminates the effects of microphonic spurious signals due to vibrations.

The primary power source is isolated from the power source used for the spectrum analyzer and the local oscillator to differentiate the power line related spurious signals from other power line related spurious signals.

NOTE

The Unit Under Test must be operated at a power line frequency different than that of the local oscillator and spectrum analyzer. This avoids the summing of the power line spurious signals.

Equipment

- Local Oscillator HP 8340A
- Spectrum Analyzer HP 3580A
- Mixer RHG DMS1-18
- Variable Frequency AC Power Source 501TC/800T, California Instruments

Procedure

1. Place the Signal Generator on a 2-inch foam pad. Connect the equipment as shown in Figure 4-11.

NOTE

Connect the mixer directly to the local oscillator to avoid any power loss.

PERFORMANCE TESTS

POWER LINE RELATED SPURIOUS SIGNALS TEST (cont'd)

Procedure
(cont'd)

*10.1010 Hz Freq.
AC Power Source*
**50174
803T**

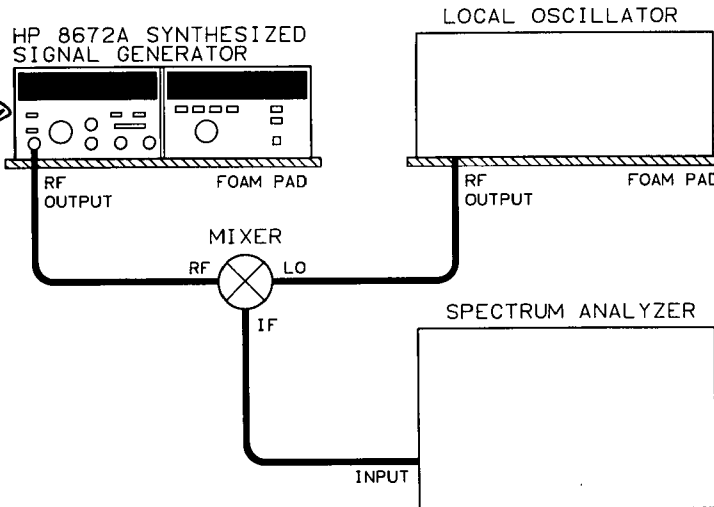

Figure 4-11. Power Line Related Spurious Signals Test Setup

2. Tune the Signal Generator to 3 000.000 MHz and set the output level to -20 dBm.
3. Set the local oscillator to 3 000.020 MHz at +7 dBm.
4. Set the spectrum analyzer start frequency to 20 kHz, resolution bandwidth to 3 Hz.
5. Set the spectrum analyzer frequency span per division to 50 Hz. Set the spectrum analyzer controls so the peak of the 20 kHz signal is at the top graticule line. Verify that the line related spurious signals of the Signal Generator do not exceed the values shown below. Record the highest spurious signal level in each offset band.

2.0 — 6.2 GHz <300 Hz offset _____ -50 dBc

300 Hz — 1 kHz offset _____ -60 dBc

6. Set the spectrum analyzer frequency span per division to 500 Hz. Measure and record the highest spurious signal level.

2.0 — 6.2 GHz >1 kHz offset _____ -65 dBc

7. Tune the Signal Generator and the local oscillator to 7 000.000 MHz and 7 000.020 MHz respectively.

PERFORMANCE TESTS

POWER LINE RELATED SPURIOUS SIGNALS TEST (cont'd)**Procedure
(cont'd)**

8. Set the spectrum analyzer frequency span per division to 50 Hz. Set the spectrum analyzer controls so that the peak of the 20 kHz signal is at the top graticule line. Verify that the line related spurious signals of the Signal Generator do not exceed the values shown below. Record the highest spurious signal level in each offset band.

6.2 — 12.4 GHz <300 Hz offset frequency _____ -44 dBc

300 Hz — 1 kHz offset frequency _____ -54 dBc

9. Set the spectrum analyzer frequency span per division to 500 Hz. Measure and record the spurious signal levels.

6.2 — 12.4 GHz >1 kHz offset frequency _____ -59 dBc

10. Tune the Signal Generator and the local oscillator to 16 000.000 MHz and 16 000.020 MHz respectively.

11. Set the spectrum analyzer frequency span per division to 50 Hz. Set the spectrum analyzer controls so that the 20 kHz signal is at the top graticule line. Verify that the line related spurious signals of the Signal Generator do not exceed the values shown in the table. Record the highest spurious signal level in each offset band.

12.4 — 18.0 GHz <300 Hz offset frequency _____ -40 dBc

300 Hz — 1 kHz offset frequency _____ -50 dBc

12. Set the spectrum analyzer frequency span per division to 500 Hz. Measure and record the spurious signal levels.

12.4 — 18.0 GHz >1 kHz offset frequency _____ -55 dBc

PERFORMANCE TESTS

4-15. SINGLE-SIDEBAND PHASE NOISE TEST

Specification

Electrical Characteristics	Performance Limits	Conditions
SPECTRAL PURITY Single-sideband Phase Noise (1 Hz bandwidth)		2.0 — 6.2 GHz
	-58 dBc	10 Hz offset from carrier
	-70 dBc	100 Hz offset from carrier
	-78 dBc	1 kHz offset from carrier
	-86 dBc	10 kHz offset from carrier
	-110 dBc	100 kHz offset from carrier
		6.2 — 12.4 GHz
	-52 dBc	10 Hz offset from carrier
	-64 dBc	100 Hz offset from carrier
	-72 dBc	1 kHz offset from carrier
	-80 dBc	10 kHz offset from carrier
	-104 dBc	100 kHz offset from carrier
		12.4 — 18.0 GHz
-48 dBc	10 Hz offset from carrier	
-60 dBc	100 Hz offset from carrier	
-68 dBc	1 kHz offset from carrier	
-76 dBc	10 kHz offset from carrier	
-100 dBc	100 kHz offset from carrier	

Description

The RF output of the Signal Generator is mixed with a local oscillator to obtain a 40 kHz or 200 kHz IF signal. The phase noise sidebands are observed on a spectrum analyzer. Correction factors are applied to compensate for using the spectrum analyzer in the log mode, for local oscillator noise contributions, and for using bandwidths wider than 1 Hz.

NOTE

Normally, phase quadrature needs to be maintained between the Signal Generator and the local oscillator for true phase noise measurement. However, the additional amplitude noise components are so small that they are not significant in these tests.

Equipment

- Local Oscillator HP 8340A
- Low Frequency Spectrum Analyzer HP 3580A
- High Frequency Spectrum Analyzer HP 8566B
- Mixer RHG DMS1-18

PERFORMANCE TESTS

SINGLE-SIDEBAND PHASE NOISE TEST (cont'd)

NOTE

The signal-to-phase noise ratio as measured must be corrected to compensate for 3 errors contributed by the measurement system. These are

a. Using the spectrum analyzer in the log mode requires a +2.5 dB correction.

b. Equal noise contributed by the local oscillator requires a -3 dB correction.

c. The spectrum analyzer noise measurement must be normalized to a 1 Hz noise equivalent bandwidth. The noise equivalent bandwidth for HP spectrum analyzers is 1.2 times the 3 dB bandwidth.

For a 3 Hz bandwidth, the correction factor for the normalized measurement bandwidth would be:

$$\begin{aligned} \text{Normalizing Factor dB} &= 10 \log (1.2 \times 3 \text{ Hz}/1\text{Hz}) \\ &= 5.56 \text{ dB.} \end{aligned}$$

The total correction for 3 Hz bandwidth would be:

$$\text{True measurement (dBc)} = \text{Reading (dBc)} - 5.56 + 2.5 - 3 = \text{Reading (dBc)} - 6.06 \text{ dB.}$$

Procedure

1. Set the low frequency spectrum analyzer's start frequency to 40 kHz, resolution bandwidth to 1 Hz, and frequency span per division to 5 Hz.
2. Connect the equipment as shown in Figure 4-12.

NOTE

Connect the mixer directly to the local oscillator to avoid any power loss.

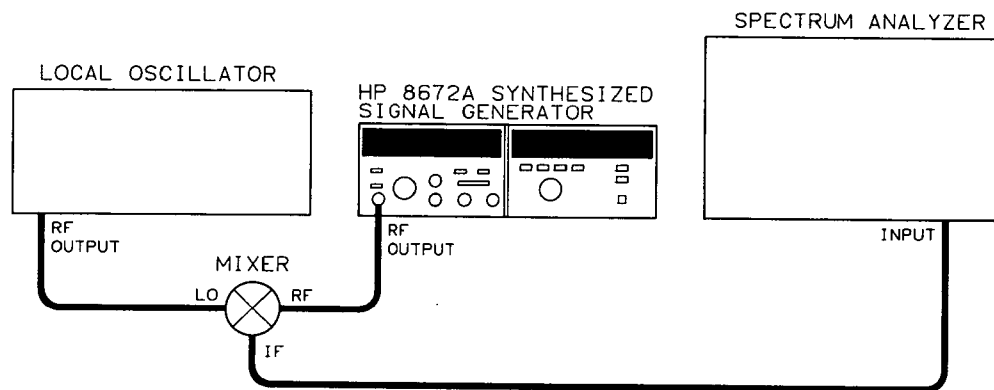

Figure 4-12. Single-Sideband Phase Noise Test Setup

3. Tune the Signal Generator to 6 100.000 MHz and set the output level to -20 dBm.
4. Set the local oscillator to 6 100.040 MHz at +8 dBm.

PERFORMANCE TESTS

SINGLE-SIDEBAND PHASE NOISE TEST (cont'd)

Procedure (cont'd)

5. Set the spectrum analyzer controls so that the peak of the 40 kHz signal is at the top graticule line.
6. Observe the phase noise level 10 Hz from the carrier. It should be greater than 56.7 dB below the carrier. Record the measured level.

Measured _____
 Correction -1.30 dB
 Actual level _____ <-58 dBc

7. Tune the Signal Generator and the local oscillator to 12 200.000 MHz and 12 200.040 MHz respectively.
8. Observe the phase noise level 10 Hz from the carrier. It should be greater than 50.07 dB below the carrier. Record the measured level.

Measured _____
 Correction -1.30 dB
 Actual level _____ <-52 dBc

9. Tune the Signal Generator and the local oscillator to 18 000.000 MHz and 18 000.039 MHz respectively.
10. Observe the noise level 10 Hz from the carrier. It should be greater than 46.7 dB below the carrier. Record the measured level.

Measured _____
 Correction -1.30 dB
 Actual level _____ <-48 dBc

11. Set the spectrum analyzer controls for a resolution bandwidth of 3 Hz and a frequency span per division of 20 Hz. Using a 3 Hz bandwidth requires a 6.06 dB correction factor.
12. Repeat steps 3 through 10 except observe the noise 100 Hz from the carrier. Record the results below.

Frequency	Measured	Correction	Actual	Limit
6100.000 MHz	_____	-6.06 dB =	_____	-70 dBc
12 200.000 MHz	_____	-6.06 dB =	_____	-64 dBc
18 000.000 MHz	_____	-6.06 dB =	_____	-60 dBc

13. For the remainder of this procedure, use the high frequency spectrum analyzer. Set the spectrum analyzer resolution bandwidth to 30 Hz and frequency span per division to 200 Hz. The 30 Hz bandwidth requires 16.06 dB correction.
14. Tune the Signal Generator and the local oscillator to 6 100.000 MHz and 6 100.200 MHz respectively.

PERFORMANCE TESTS

SINGLE-SIDEBAND PHASE NOISE TEST (cont'd)

Procedure (cont'd)

15. Tune the spectrum analyzer to place the 200 kHz IF signal at the left edge of the display. Set the spectrum analyzer controls to place the peak of the signal at the top graticule line. Increase the log reference level control to move the peak of the carrier 20 dB above the top graticule line. (The top graticule line is now -20 dBc.)
16. Observe the phase noise level 1 kHz from the carrier. The observed level should be greater than 62 dB below the carrier. Record the measured level.

Measured _____
 Correction -16.06 dB
 Actual Level _____ < -78 dBc

17. Tune the Signal Generator and the local oscillator to 12 200.000 MHz and 12 200.200 MHz respectively.
18. Observe the noise level 1 kHz from the carrier. The observed level should be greater than 56 dB below the carrier. Record the measured level.

Measured _____
 Correction -16.06 dB
 Actual Level _____ < -72 dBc

19. Tune the Signal Generator and the local oscillator to 18 000.000 MHz and 18 000.200 MHz respectively.
20. Observe the noise level 1 kHz from the carrier. The observed level should be greater than 52 dB below the carrier. Record the measured level.

Measured _____
 Correction -16.06 dB
 Actual Level _____ < -68 dBc

21. Set the spectrum analyzer for a resolution bandwidth of 300 Hz and a frequency span per division of 2 kHz. Using a 300 Hz bandwidth requires a 26.06 dB correction factor.
22. Repeat steps 14 through 20 except observe the noise ^{OK} 10 kHz from the carrier. Record the results below.

Frequency	Measured	Correction	Actual	Limit
6100.000 MHz	_____	-26.06 dB	_____	-86 dBc
12 200.000 MHz	_____	-26.06 dB =	_____	-80 dBc
18 000.000 MHz	_____	-26.06 dB =	_____	-76 dBc

23. Set the spectrum analyzer controls for a resolution bandwidth of 3 kHz and a frequency span per division of 20 kHz. Using a 3 kHz bandwidth requires a 36.06 dB correction factor.

PERFORMANCE TESTS

SINGLE-SIDEBAND PHASE NOISE TEST (cont'd)

100kHz

**Procedure
(cont'd)**

24. Repeat steps 14 through 20 except observe the noise *100kHz* from the carrier. Record the results below.

Frequency	Measured	Correction	Actual	Limit
6100.000 MHz	_____	-36.06 dB =	_____	-110 dBc
12 200.000 MHz	_____	-36.06 dB =	_____	-100 dBc
18 000.000 MHz	_____	-36.06 dB =	_____	-100 dBc

PERFORMANCE TESTS

4-16. EXTERNAL FM ACCURACY AND METER ACCURACY

Specification

Electrical Characteristics	Performance Limits	Conditions
Indicated Meter Accuracy (at 100 kHz rate): +15°C to +35°C 0°C to +55°C Accuracy Relative to FM Input Signal Level (at 100 kHz rate): +15°C to +35°C 0°C to +55°C	±10% of full scale ±15% of full scale ±7% of range ±10% of range	

NOTE

For FM rates other than 100 kHz, add the FM frequency response specification.

Description

With the FM rate fixed, the FM peak deviation is set to a reference point. At this point, the meter indication of peak deviation and the modulation drive level should be within specifications.

Equipment

- Local Oscillator HP 8340A
- Frequency Counter HP 5340A
- Measuring Receiver HP 8902A
- Test Oscillator HP 8116A
- Digital Voltmeter HP 3456A
- Double Balanced Mixer RHG DM1-18

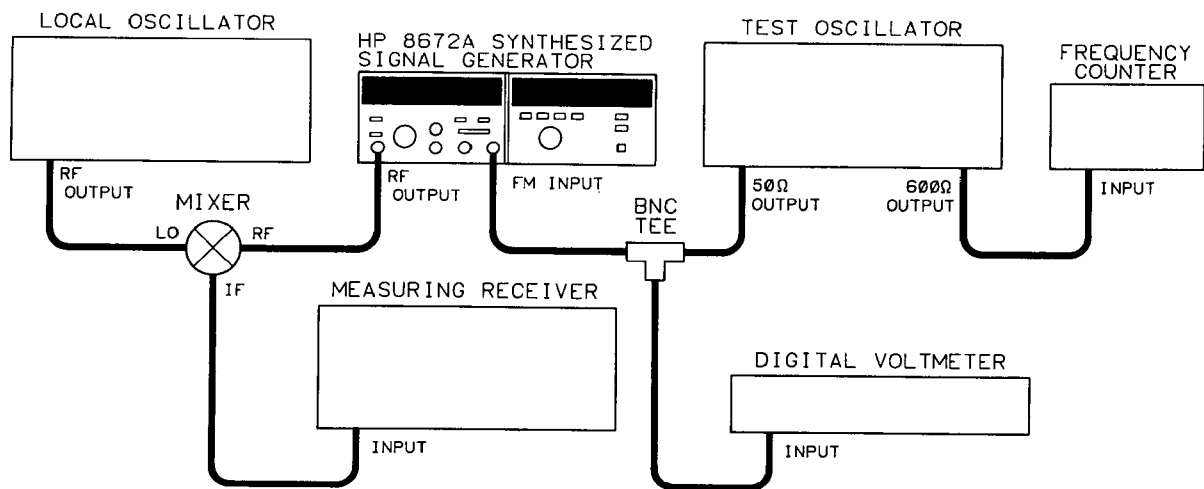

Figure 4-13. External FM Accuracy and Meter Accuracy Test Setup

PERFORMANCE TESTS

EXTERNAL FM ACCURACY AND METER ACCURACY (cont'd)

Procedure

1. Connect the equipment as shown in Figure 4-13.
2. Set the Signal Generator as follows:

FREQUENCY 3000 MHz
 OUTPUT LEVEL RANGE -10 dB
 OUTPUT LEVEL VERNIER 0 dBm
 FM DEVIATION switch 0.3 MHz
 METER MODE switch FM

3. Tune the local oscillator to 3063 MHz with an output amplitude of +8.0 dBm.
4. Set the measuring receiver as follows:

MEASUREMENT FM
 DETECTOR Peak
 HP FILTER 50 Hz
 LP FILTER 15 kHz
 Measurement Frequency 63 MHz
5. Tune the test oscillator to 100 kHz.
6. Adjust the test oscillator's output level to obtain 240 kHz peak deviation as read on the measuring receiver display. (This should occur near 0.56 Vrms.)
7. The Signal Generator's front panel meter should read between 2.10 and 2.70 (240 kHz peak deviation). Record the reading.

2.10 _____ 2.70
8. The DVM should read between 0.53 and 0.61 Vrms. Record the level.

0.53 _____ 0.61 Vrms
9. If the FM accuracy is not within specifications, perform the FM Adjustments in Section V.

PERFORMANCE TESTS

4-17. FM FREQUENCY RESPONSE

Specification

Electrical Characteristics	Performance Limits	Conditions
FM Frequency Response (Relative to 100 kHz rate): 100 Hz to 3 MHz 3 kHz to 3 MHz	± 2.0 dB ± 2.0 dB	30 and 100 kHz/V ranges 300 kHz and 1,3, and 10 MHz/V ranges

Description

The test oscillator is tuned to 100 kHz and the output level is adjusted to obtain the first carrier (Bessel) null. This output level and the 100 kHz rate are the references for later calculations. At other modulation rates, the output level is set and measured for the first carrier null. The measured voltage and the rate are then compared to the established reference to determine frequency response.

Equipment

- AC Voltmeter HP 400E
- Frequency Counter HP 5343A
- Spectrum Analyzer HP 8566B
- Test Oscillator HP 8116A

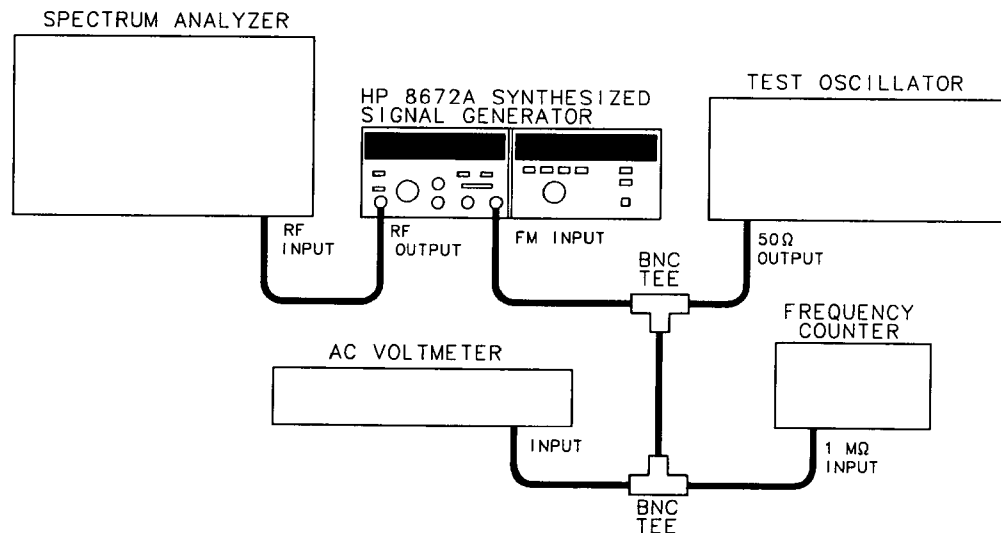

Figure 4-14. FM Frequency Response Test Setup

1. Connect the equipment as shown in Figure 4-14.
2. Set the Signal Generator as follows:
 - FREQUENCY 3000 MHz
 - OUTPUT LEVEL RANGE 0 dB
 - OUTPUT LEVEL VERNIER 0 dBm
 - FM DEVIATION switch 10 MHz

PERFORMANCE TESTS

FM FREQUENCY RESPONSE (cont'd)

Procedure (cont'd)

3. Adjust the spectrum analyzer to display the RF signal. Set the span to 1 MHz (100 kHz per division) initially. (It will be necessary to change the span for later measurements.) Set the other controls as needed for a calibrated display.
4. Tune the test oscillator to 100 kHz.
5. Adjust the test oscillator's output level to obtain the first carrier (Bessel) null. Record the voltage indicated on the AC voltmeter in the table. (The voltage should be approximately 0.017 Vrms).
6. Tune the test oscillator to 3 kHz (f_x). Starting with 0 volt, adjust the output voltage (V_x) to obtain the first carrier null. Record the measured frequency and voltage in the table.
7. Repeat step 6 for each of the remaining frequencies listed in the following table.

Modulation Frequency (kHz)	Measured Frequency (f_x) (kHz)	Measured Voltage (V_x) (mVrms)	Calculated Response (dB)	Expected Voltage (mVrms)
3	_____	_____	_____	0.51
30	_____	_____	_____	5.1
100	100.0	_____	0	17
300	_____	_____	_____	54
1000	_____	_____	_____	170
3000	_____	_____	_____	540

8. Use the following equation to calculate the frequency response of the FM circuits.

$$dB = 20 \log \frac{V_x}{V_{100 \text{ kHz}}} - 20 \log \frac{f_x}{100 \text{ kHz}}$$

where dB = the calculated frequency response
 V_x = the voltage measured at f_x
 $V_{100 \text{ kHz}}$ = the reference voltage measured at 100 kHz
 f_x = the measured frequency.

9. If the FM frequency response is not within specifications, perform the FM Driver Adjustment and the FM Adjustment in Section V.

PERFORMANCE TESTS

4-18. FM HARMONIC AND NON-HARMONIC DISTORTION

Specification

Electrical Characteristics	Performance Limits	Conditions
FM Harmonic and Non-Harmonic Distortion:		
<3 kHz	<12%	
3 kHz to 20 kHz	Decreasing linearly with frequency to 5% at 20 kHz.	
20 kHz to 100 kHz	<5%	

Description

The Signal Generator is frequency modulated and the modulated output is detected by a measuring receiver. The distortion on the detected signal is measured and displayed on an audio analyzer.

Equipment

- Local Oscillator HP 8340A
- Measuring Receiver HP 8902A
- Audio Analyzer HP 8903B
- Test Oscillator HP 8116A
- Double Balanced Mixer RHG DM1-18

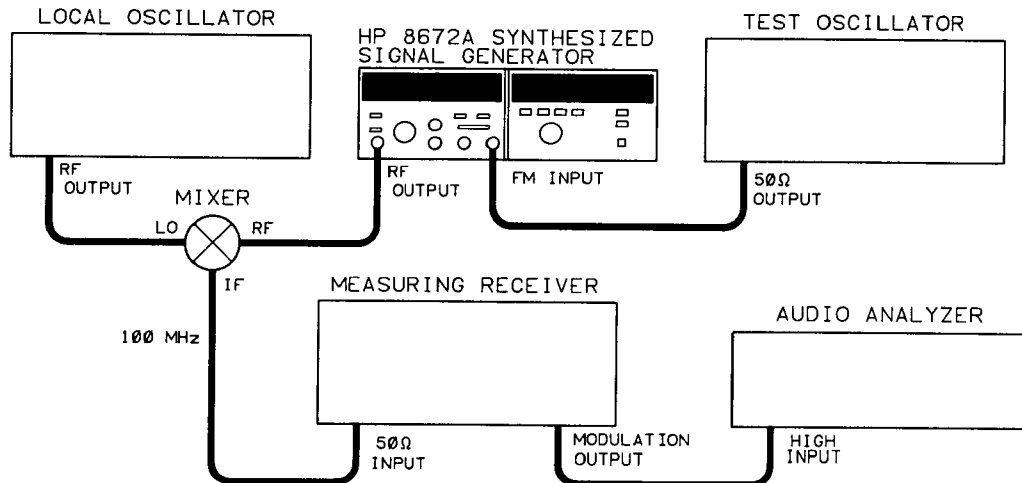

Figure 4-15. FM Harmonic and Non-Harmonic Distortion Test Setup

Procedure

1. Connect the equipment as shown in Figure 4-15.
2. Set the Signal Generator as follows:
 - FREQUENCY 3000 MHz
 - OUTPUT LEVEL RANGE 0 dB
 - OUTPUT LEVEL VERNIER 0 dBm
 - METER MODE switch FM
 - FM DEVIATION switch 0.03 MHz

PERFORMANCE TESTS

FM HARMONIC AND NON-HARMONIC DISTORTION (cont'd)

Procedure (cont'd)

3. Tune the local oscillator to 3063 MHz at +7 dBm.

4. Set the measuring receiver as follows:

- MEASUREMENT FM
- DETECTOR Peak
- HP FILTER 50 Hz
- LP FILTER 15 kHz
- Measurement Frequency 63 MHz

5. Set the audio analyzer as follows:

- MEASUREMENT DISTN
- 80 kHz FILTER OFF
- AUTOMATIC OPERATION selected

6. Tune the test oscillator to 1 kHz and adjust the output level to obtain a reading of 5 kHz FM on the measuring receiver.

7. Read the distortion displayed on the audio analyzer. The distortion should be less than 12%.

_____ <12%

8. Tune the test oscillator to 20 kHz. The distortion should be less than or equal to 5%.

_____ ≤5%

9. Slowly sweep the test oscillator's frequency from 20 kHz to 100 kHz. Verify that the distortion is less than 5% over the entire range.

10. If the FM distortion is not within specifications, perform the FM Adjustments in Section V.

PERFORMANCE TESTS

4-19. RESIDUAL FM

Specification

Electrical Characteristics	Performance Limits	Conditions	
Residual FM in FM and CW Modes (Noise and Power line related):			
	CW, 30, 100 kHz/V	16 Hz-rms	300 Hz—3 kHz post detection bandwidth
		80 Hz-rms	50 Hz—15 kHz post detection bandwidth
	300 kHz/V, 1, 3, 10 MHz/V	20 Hz-rms	300 Hz—3 kHz post detection bandwidth
	100 Hz-rms	50 Hz—15 kHz post detection bandwidth	

Description

The RF output of the Signal Generator is mixed with the RF output of a local oscillator. The residual FM on the IF signal is measured and displayed on a measuring receiver. If greater resolution is desired, a digital voltmeter may be used to measure the demodulated output of the modulation analyzer. The voltage measured in mVrms is equal to peak deviation in Hz.

Equipment

- Local Oscillator HP 8340A
- Measuring Receiver HP 8902A
- Double Balanced Mixer RHG DM1-18
- 50 Ohm BNC Termination HP 11593A

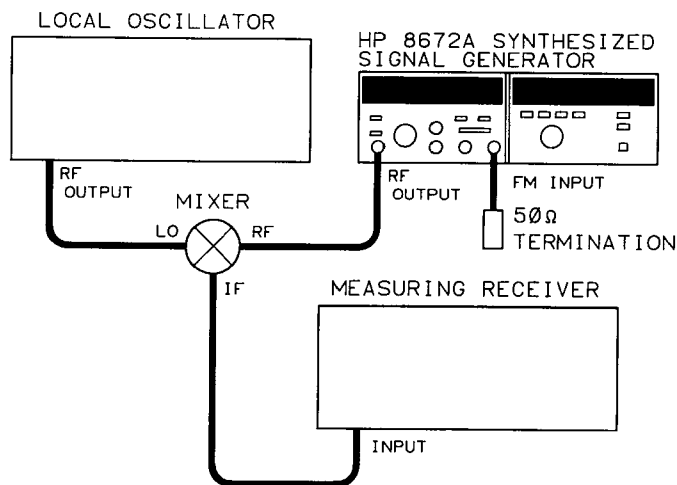

Figure 4-16. Residual FM Test Setup

Procedure

1. Connect the equipment as shown in Figure 4-16.
2. Set the Signal Generator as follows:

PERFORMANCE TESTS

RESIDUAL FM (cont'd)

Procedure (cont'd)	FREQUENCY	3000 MHz
	OUTPUT LEVEL RANGE	0 dB
	OUTPUT LEVEL VERNIER	0 dBm
	METER MODE switch	LEVEL
	FM switch	0.03 MHz

3. Tune the local oscillator to 3063 MHz with an output amplitude of + 7.0 dBm.
 4. Set the measuring receiver as follows:

MEASUREMENT	FM
DETECTOR	rms
HP FILTER	300 Hz
LP FILTER	3 kHz
Measurement Frequency	63 MHz
 5. Read the residual FM indicated on the measuring receiver's display.
 6. Because two independent instruments are being measured, divide the reading by two to obtain probable residual FM for a single instrument. This assumes the two instruments are of equal performance. The result should be less than 16 Hz in a 300 Hz to 3 kHz post detection bandwidth.

_____ <16 Hz-rms
 7. Tune the Signal Generator to 12 200 MHz. Tune the local oscillator to 12 263 MHz. Measure the residual FM as in steps 5 and 6. The result should be less than 32 Hz.

_____ <32 Hz-rms
 8. Tune the Signal Generator to 14 000 MHz. Tune the local oscillator to 14 063 MHz. Measure the residual FM as in steps 5 and 6. The result should be less than 48 Hz.

_____ <48 Hz-rms
 9. Set the measuring receiver as follows:

HP Filter	50 Hz
LP Filter	15 kHz
 10. Tune the Signal Generator to 3000 MHz.
 11. Tune the local oscillator to 3063 MHz.
 12. Read the residual FM indicated on the measuring receiver's display.
 13. Because two independent instruments are being measured, divide the reading by two to obtain probable residual FM for a single instrument. The result should be less than 80 Hz in a 50 Hz to 15 kHz post detection bandwidth.

_____ <80 Hz-rms
-

PERFORMANCE TESTS

RESIDUAL FM (cont'd)**Procedure
(cont'd)**

14. Tune the Signal Generator to 12 200 MHz. Tune the local oscillator to 12 263 MHz. Measure the residual FM as in steps 12 and 13. The result should be less than 160 Hz.

_____ <160 Hz-rms

15. Tune the Signal Generator to 14 000 MHz. Tune the local oscillator to 14 063 MHz. Measure the residual FM as in steps 12 and 13. The result should be less than 240 Hz.

_____ <240 Hz-rms

16. If the residual FM is not within specifications, perform the Single Sideband Phase Noise Performance Test.

PERFORMANCE TESTS

4-20. INCIDENTAL FM

Specification

Electrical Characteristics	Performance Limits	Conditions
Incidental FM: 2.0 to 6.2 GHz 6.2 to 12.4 GHz 12.4 to 18.0 GHz	<7 kHz <18 kHz <12 kHz	Rates ≤10 kHz, 30% AM Depth.

Description

The output of the Signal Generator is amplitude modulated. The modulated output is detected by a measuring receiver. The incidental FM present on the detected signal is measured and displayed on the measuring receiver.

Equipment

- Local Oscillator HP 8340A
- Measuring Receiver HP 8902A
- Test Oscillator HP 8116A
- Double Balanced Mixer RHG DM1-18

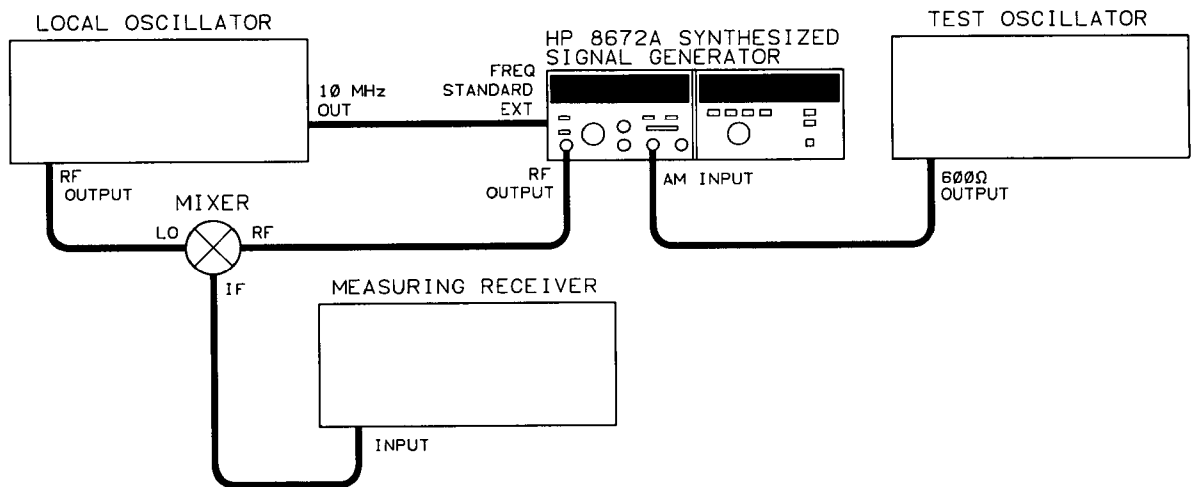

Figure 4-17. Incidental FM Test Setup

Procedure

1. Connect the equipment as shown in Figure 4-17.
2. Set the Signal Generator as follows:
 - FREQUENCY 6000 MHz
 - OUTPUT LEVEL RANGE -10 dB
 - OUTPUT LEVEL VERNIER 0 dBm
 - AM switch 100%
 - METER MODE switch AM
3. Tune the local oscillator to 6063 MHz with an output amplitude of +7.0 dBm.

PERFORMANCE TESTS

INCIDENTAL FM (cont'd)**Procedure
(cont'd)**

4. Set the measuring receiver as follows:

MEASUREMENT	AM
DETECTOR	Peak
HP FILTER	50 Hz
LP FILTER	15 kHz
Measurement Frequency	63 MHz

5. Tune the test oscillator to 10 kHz.
6. Adjust the test oscillator output level to obtain a reading of 30% AM as indicated on the measuring receiver.
7. Set the measuring receiver to measure FM.
8. Measure and record the incidental FM as indicated on the measuring receiver. The incidental FM should be less than 7 kHz.
- Incidental FM _____ <7 kHz
9. If the incidental FM is not within specifications, refer to the troubleshooting information in Section VIII.

PERFORMANCE TESTS

4-21. AM DISTORTION

Specification

Electrical Characteristics	Performance Limits	Conditions
AM Distortion (+15 C to +35 C):		Rates <10 kHz, Output power <0 dBm.
30% Depth	<3%	
50% Depth	<4%	
75% Depth	<5%	

Description

The Signal Generator is amplitude modulated and the modulated output is detected by a measuring receiver. The distortion present on the detected signal is measured and displayed on an audio analyzer.

Equipment

- Local Oscillator HP 8340A
- Measuring Receiver HP 8902A
- Audio Analyzer HP 8903B
- Test Oscillator HP 8116A
- Double Balanced Mixer RHG DM1-18

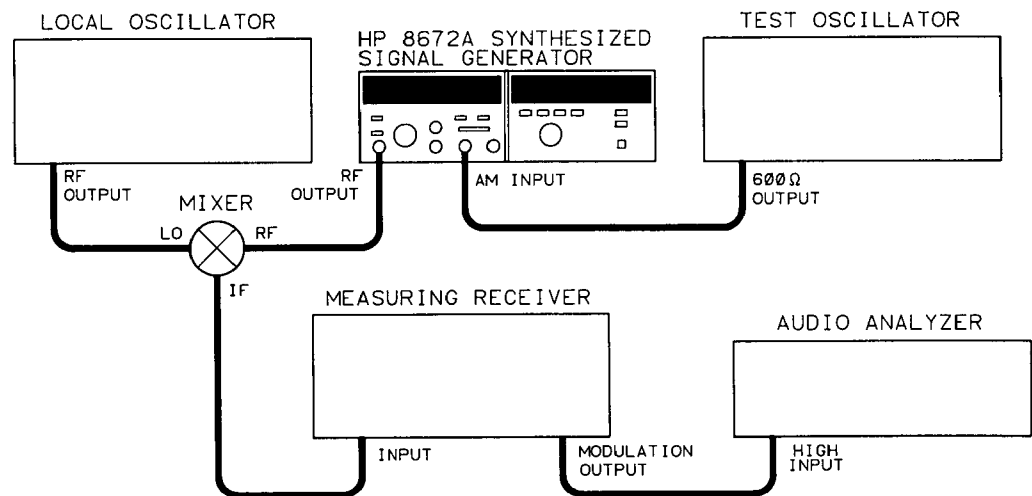

Figure 4-18. AM Distortion Test Setup

Procedure

1. Connect the equipment as shown in Figure 4-18.
2. Set the Signal Generator as follows:
 - FREQUENCY 3000 MHz
 - OUTPUT LEVEL RANGE -10 dB
 - OUTPUT LEVEL VERNIER 0 dBm
 - AM switch 30%
 - METER MODE switch AM
3. Tune the local oscillator to 3063 MHz with an output amplitude of +7.0 dBm.

PERFORMANCE TESTS

AM DISTORTION (cont'd)

**Procedure
(cont'd)**

4. Set the measuring receiver as follows:

- MEASUREMENT AM
- DETECTOR Peak
- HP FILTER 50 Hz
- LP FILTER 15 kHz
- Measurement Frequency 63 MHz

5. Tune the test oscillator to 1.0 kHz.

6. Adjust the test oscillator's output level as needed to obtain a reading of 30% AM on the measuring receiver.

7. Set the audio analyzer to measure the distortion (in percent) of the detected signal from the measuring analyzer. Record the reading.

Distortion (30% AM Depth) _____ <3%

8. Set the Signal Generator's AM switch to 100%.

9. Adjust the test oscillator's output level to obtain a reading of 50% AM on the measuring receiver.

10. Measure the distortion (in percent) of the detected signal from the measuring receiver. Record the reading.

Distortion (50% AM Depth) _____ <4%

11. Adjust the test oscillator's output level to obtain a reading of 75% AM on the measuring receiver.

12. Measure the distortion (in percent) of the detected signal from the measuring receiver. Record the reading.

Distortion (75% AM Depth) _____ <5%

13. If the AM Distortion is not within specifications, refer to the troubleshooting information in Section VIII.

PERFORMANCE TESTS

4-22. EXTERNAL AM ACCURACY AND METER ACCURACY

Specification

Electrical Characteristics	Performance Limits	Conditions
AM Depth (+15°C to +35°C): 2.0 to 6.2 GHz 6.2 to 12.4 GHz 12.4 to 18.0 GHz	0–75% 0–60% 0–50%	Output level of 0 dBm and below
Sensitivity: 30% Range 100% Range	30%/Vpk 100%/Vpk	Maximum input 1 Vpk into 600Ω nominal; AM depth is linearly controlled by varying input level between 0 and 1V peak.
Indicated Meter Accuracy:	±5% of range	100 Hz to 10 kHz rates.
Accuracy Relative to AM Input Signal Level:	±10% of range	100 Hz to 10 kHz rates

Description

The specified parameters are tested by measuring the modulation level with a measuring receiver and comparing the reading to the Signal Generator's AM meter indications and the input drive voltage from the test oscillator.

Equipment

- Local Oscillator HP 8340A
- Measuring Receiver HP 8902A
- Digital Voltmeter HP 3456A
- Test Oscillator HP 8116A
- Double Balanced Mixer RHG DM1-18

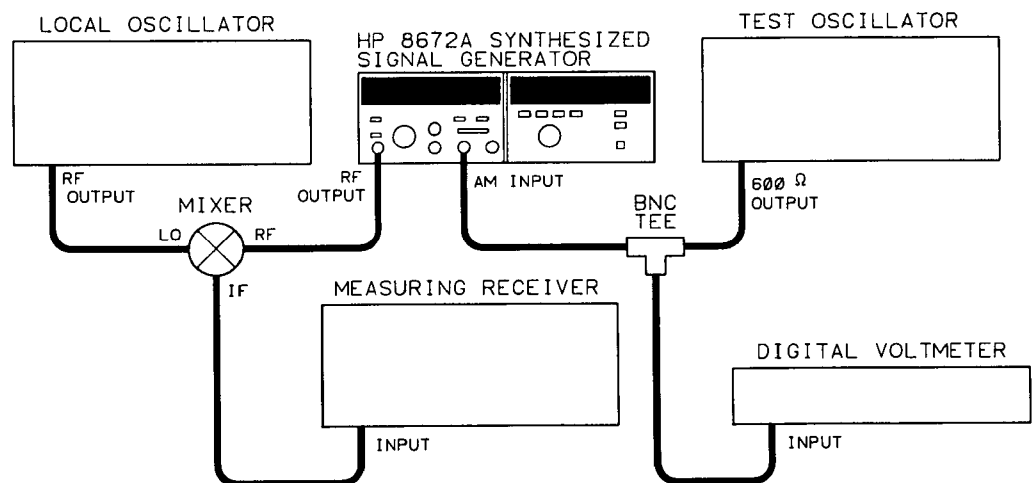

Figure 4-19. External AM Accuracy and Meter Accuracy Test Setup

PERFORMANCE TESTS

EXTERNAL AM ACCURACY AND METER ACCURACY (cont'd)

Procedure

1. Connect the equipment as shown in Figure 4-19.
2. Set the Signal Generator as follows:
 FREQUENCY 3000 MHz
 OUTPUT LEVEL RANGE -10 dB
 OUTPUT LEVEL VERNIER +3 dBm
 AM Switch 30%
 METER MODE Switch AM
3. Tune the local oscillator to 3063 MHz with an output amplitude of +7.0 dBm.
4. Set the measuring receiver as follows:
 MEASUREMENT AM
 DETECTOR Peak
 HP FILTER 50 Hz
 LP FILTER 15 kHz
 Measurement Frequency 63 MHz
5. Set the DVM to measure Vrms.
6. Tune the test oscillator to 10 kHz.
7. Adjust the test oscillator's output level for 30% AM depth as indicated on the measuring receiver.
8. Read the AM depth indicated on the Signal Generator's AM meter. Verify that the meter reading is within specifications. Record the reading in the table below.

Signal Generator Frequency (MHz)	AM Range Switch	Measuring Receiver Reading	Signal Generator Meter Reading		
			Min.	Actual	Max.
3000	30%	30%	28.5%	_____	31.5%
3000	100%	75%	70%	_____	80%
7000	100%	60%	55%	_____	65%
13000	100%	50%	45%	_____	55%

9. Read the test oscillator's signal level on the DVM. Verify that the reading is within specifications. Record the reading in the table below.

Signal Generator Frequency (MHz)	AM Range Switch	Measuring Receiver Reading	DVM Reading (mVrms)		
			Min.	Actual	Max.
3000	30%	30%	636	_____	778
3000	100%	75%	460	_____	601
7000	100%	60%	354	_____	495
13000	100%	50%	283	_____	424

PERFORMANCE TESTS

EXTERNAL AM ACCURACY AND METER ACCURACY (cont'd)**Procedure
(cont'd)**

10. Set the Signal Generator's AM switch to 100%.
11. Adjust the test oscillator's output level control for 75% AM depth as indicated on the measuring receiver.
12. Repeat steps 8 and 9.
13. Tune the Signal Generator to 7000 MHz. Tune the local oscillator to 7063 MHz.
14. Adjust the test oscillator's output level control for 60% AM depth as indicated on the measuring receiver.
15. Repeat steps 8 and 9.
16. Tune the Signal Generator to 13 000 MHz. Tune the local oscillator to 13 063 MHz.
17. Adjust the test oscillator's output level control for 50% AM depth as indicated on the measuring receiver.
18. Repeat steps 8 and 9.
19. If the meter accuracy is not within specifications, perform the AM Meter Adjustment in Section 5. If the input accuracy is not within specifications, refer to the troubleshooting information in Section VIII.

PERFORMANCE TESTS

4-23. AM BANDWIDTH

Specification

Electrical Characteristics	Performance Limits	Conditions
AM Bandwidth: For 3 dB bandwidth	10 Hz to 100 kHz	

Description

The Signal Generator is modulated with a signal of fixed amplitude at various frequencies. A crystal detector is used to demodulate the signal. The amplitude of the recovered modulation is observed on an oscilloscope. AM bandwidth is determined by the changes in the amplitude of the observed signal.

Equipment

- Test Oscillator HP 8340A
- Oscilloscope HP 1980B
- Crystal Detector HP 8470B Option 012
- 600 Ohm Feedthru Termination HP 11095A

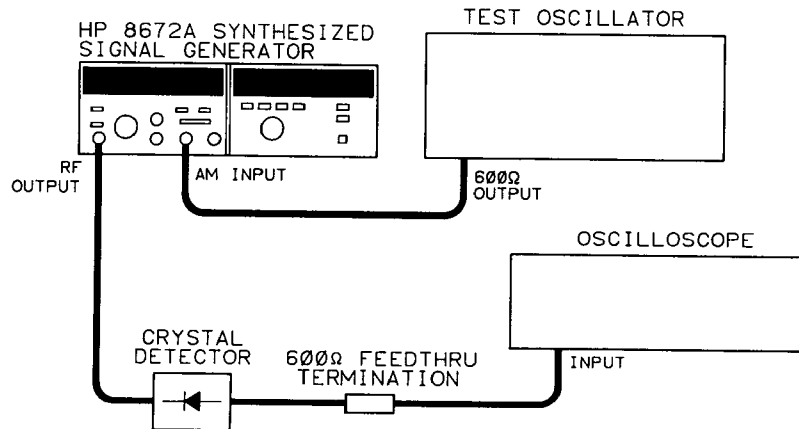

Figure 4-20. AM Bandwidth Test Setup

Procedure

1. Connect the equipment as shown in Figure 4-20.
2. Set the Signal Generator as follows:
 - FREQUENCY 3000 MHz
 - OUTPUT LEVEL RANGE 0 dB
 - OUTPUT LEVEL VERNIER 0 dBm
 - AM switch 30 %
 - METER MODE switch AM
3. Tune the test oscillator to 10 kHz and adjust the output level to obtain 30% AM as indicated on the Signal Generator's front panel meter.
4. Set the oscilloscope to obtain a 5 division peak-to-peak display of the demodulated waveform. The 5 division display represents the nominal 0 dB point. A 3.5 division display is 3 dB down.

PERFORMANCE TESTS

AM BANDWIDTH (cont'd)**Procedure
(cont'd)**

5. Tune the test oscillator's frequency over the range of 10 Hz to 100 kHz while observing the signal amplitude on the oscilloscope. The signal should remain greater than 3.5 divisions. Record the minimum amplitude.

Minimum amplitude _____ > 3.5 div.

6. If the AM bandwidth is not within specifications, perform the AM Bandwidth Adjustment in Section V.

PERFORMANCE TESTS

4-24. INCIDENTAL AM

Specification

Electrical Characteristics	Performance Limits	Conditions
Incidental AM:	<10%	Rates ≤ 100 kHz, peak deviation ≤ 1 MHz

Description

The Signal Generator is frequency modulated and the incidental AM present on the RF signal is detected, measured, and displayed on the measuring receiver.

Equipment

- Local Oscillator HP 8340A
- Measuring Receiver HP 8902A
- Test Oscillator HP 8116A
- Double Balanced Mixer RHG DM1-18

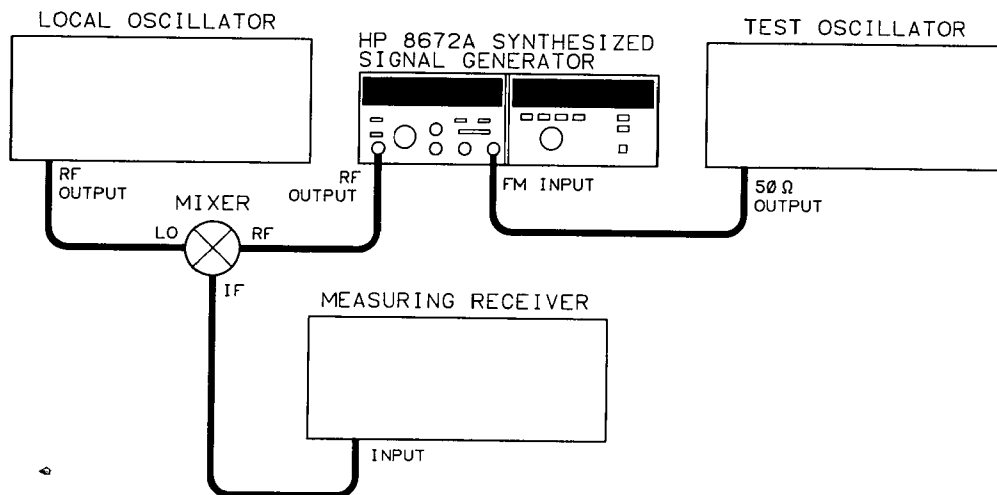

Figure 4-21. Incidental AM Test Setup

Procedure

1. Connect the equipment as shown in Figure 4-21.
2. Set the Signal Generator as follows:
 - FREQUENCY 2000 MHz
 - OUTPUT LEVEL RANGE 0 dB
 - OUTPUT LEVEL VERNIER 0 dBm
 - FM DEVIATION switch 1 MHz
 - METER MODE switch FM
3. Set the measuring receiver as follows:
 - MEASUREMENT FM
 - DETECTOR Peak +
 - HP FILTER 50 Hz
 - LP FILTER 15 kHz
 - FM DE-EMPHASIS OFF
 - Measurement Frequency 63 MHz

PERFORMANCE TESTS

INCIDENTAL AM (cont'd)**Procedure
(cont'd)**

4. Tune the local oscillator to 2063 MHz with an output amplitude of +7.0 dBm.
5. Tune the test oscillator to 100 kHz.
6. Adjust the test oscillator's output level for 400 kHz FM peak deviation as indicated on the measuring receiver.
7. Set the measuring receiver to measure AM.
8. Read the incidental AM as indicated on the measuring receiver. Verify that the reading is within specifications.
9. Tune the Signal Generator to 6200 MHz. Tune the local oscillator to 6263 MHz.
10. If necessary, re-adjust the test oscillator's output level for 400 kHz FM peak deviation.
11. Repeat step 8.
12. Tune the Signal Generator to 12 400 MHz. Tune the local oscillator to 12 463 MHz.
13. If necessary, re-adjust the test oscillator's output level for 400 kHz FM peak deviation.
14. Repeat step 8.
15. If the incidental AM is not within specifications, refer to the troubleshooting information in Section VIII.

PERFORMANCE TESTS

4-25. INTERNAL TIME BASE AGING RATE

Specification

Electrical Characteristics	Performance Limits	Conditions
FREQUENCY Reference Oscillator Frequency Aging Rate Accuracy and Stability	10 MHz $<5 \times 10^{-10}/\text{day}$ Same as reference oscillator	After a 10 day warmup (typically 24 hours in a normal operating environment)

Description

A reference signal from the Signal Generator (10 MHz OUT) is connected to the oscilloscope's vertical input. A frequency standard (with long term stability greater than 1×10^{-10}) is connected to the trigger input. The time required for a specific phase change is measured immediately and after a period of time. The aging rate is inversely proportional to the absolute value of the difference in the measured times.

Equipment

Frequency Standard HP 5065A
 Oscilloscope HP 1980B

NOTE

Be sure the Signal Generator has had 10 days to warm up before beginning this test. If the Signal Generator was disconnected from the power line for less than 24 hours, only a 24 hour warm-up is needed.

Procedure

1. Set the rear panel FREQ REFERENCE INT-EXT switch to the INT position.
2. Connect the equipment as shown in Figure 4-22.

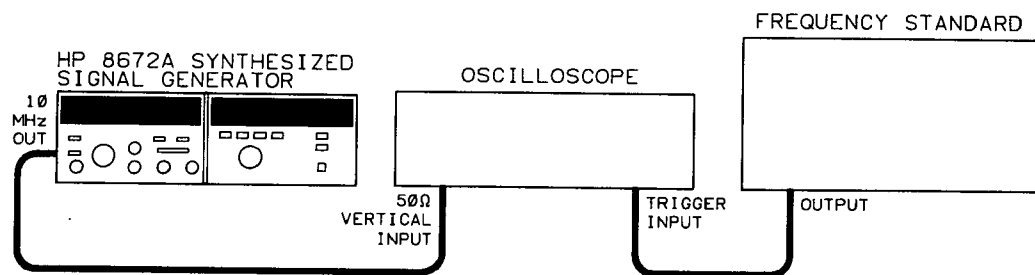

Figure 4-22. Internal Time Base Aging Rate Test Setup

3. Adjust the oscilloscope controls for a stable display of the 10 MHz Signal Generator output.

PERFORMANCE TESTS

INTERNAL TIME BASE AGING RATE (cont'd)**Procedure
(cont'd)**

4. Measure the time required for a phase change of 360°. Record the time (T_1) in seconds.

$$T_1 = \text{_____ s}$$

5. Wait for a period of time (from 3 to 24 hours) and re-measure the phase change time. Record the period of time between measurements (T_2) in hours and the new phase change time (T_3) in seconds.

$$T_2 = \text{_____ h}$$

$$T_3 = \text{_____ s}$$

6. Calculate the aging rate from the following equation:

$$\text{Aging Rate} = \left| \left(\frac{1 \text{ cycle}}{f} \right) \left(\frac{1}{T_1} - \frac{1}{T_3} \right) \left(\frac{T}{T_2} \right) \right|$$

where: 1 cycle = the phase change reference for the time measurement (in this case, 360°)

f = Signal Generator's reference output frequency (10 MHz)

T = specified time for aging rate (24h)

T_1 = initial time measurement(s) for a 360° (1 cycle) change

T_2 = time between measurements (h)

T_3 = final time measurement(s) for a 360° (1 cycle) change

for example:

$$\text{if } T_1 = 351\text{s}$$

$$T_2 = 3\text{h}$$

$$T_3 = 349\text{s}$$

then:

$$\text{Aging Rate} = \left| \left(\frac{1 \text{ cycle}}{10 \text{ MHz}} \right) \left(\frac{1}{351\text{s}} - \frac{1}{349\text{s}} \right) \left(\frac{24\text{h}}{3\text{h}} \right) \right|$$

$$= 1.306 \times 10^{11}$$

7. Verify that the aging rate is less than 5×10^{-10} .

NOTE

If the absolute frequencies of the frequency standard and the Signal Generator's reference oscillator are extremely close, the measurement time in steps 5 and 6 (T_1 and T_3) can be reduced by measuring the time required for a phase change of something less than 360°. Change 1 cycle in the formula (i.e., 180° = 1/2 cycle, 90° = 1/4 cycle).

$$\text{Aging Rate} \text{ _____} < 5 \times 10^{-10}/\text{day}$$

Table 4-4. Performance Test Record (1 of 7)

Hewlett-Packard Company Model HP 8672A Synthesized Signal Generator Serial Number _____ Tested by _____ Date _____					
Para. No.	Test	Results			
		Min.	Actual	Max.	
4-7.	FREQUENCY RANGE AND RESOLUTION TEST				
	Baseband Test				
	3 000.000	2 999.999	_____	3 000.001	
	2 000.000	1 999.999	_____	2 000.001	
	2 000.001	2 000.000	_____	2 000.002	
	2 001.112	2 001.111	_____	2 001.113	
	2 002.223	2 002.222	_____	2 002.224	
	2 003.334	2 003.333	_____	2 003.335	
	2 004.445	2 004.444	_____	2 004.446	
	2 005.556	2 005.555	_____	2 005.557	
	2 006.667	2 006.666	_____	2 006.668	
	2 007.778	2 007.777	_____	2 007.779	
	2 008.889	2 008.888	_____	2 008.890	
	2 009.999	2 009.998	_____	2 010.000	
	2090.000	2089.999	_____	2090.001	
	2 280.000	2 279.999	_____	2 280.001	
	2 470.000	2 469.999	_____	2 470.001	
	2 660.000	2 659.999	_____	2 660.001	
	2 850.000	2 849.999	_____	2 850.001	
	3 040.000	3 039.999	_____	3 040.001	
	3 230.000	3 229.999	_____	3 230.001	
	3 420.000	3 419.999	_____	3 420.001	
	3 610.000	3 609.999	_____	3 610.001	
	3 800.000	3 799.999	_____	3 800.001	
	3 990.000	3 989.999	_____	3 990.001	
	4 180.000	4 179.999	_____	4 180.001	
	4 370.000	4 369.999	_____	4 370.001	
	4 560.000	4 559.999	_____	4 560.001	
	4 750.000	4 749.999	_____	4 750.001	
	4 940.000	4 939.999	_____	4 940.001	
	5 130.000	5 129.999	_____	5 130.001	
	5 320.000	5 319.999	_____	5 320.001	
	5 510.000	5 509.999	_____	5 510.001	
	5 700.000	5 699.999	_____	5 700.001	
	5 900.000	5 899.999	_____	5 900.001	
	6 100.000	6 099.999	_____	6 100.001	
		Bands 2 and 3 Test			
		10 GHz, 2 kHz Resolution		_____ (✓)	
		18 GHz, 3 kHz Resolution		_____ (✓)	

Table 4-4. Performance Test Record (2 of 7)

Para. No.	Test	Results				
		Min.	Actual	Max.		
4-8.	FREQUENCY SWITCHING TIME TEST					
	Frequency Switching					
	18 GHz to 2.1 GHz		_____	15 ms		
	2.1 GHz to 18 GHz		_____	15 ms		
	Amplitude Recovery					
	2.1 to 6.1 GHz, 1 kHz resolution band		_____	15 ms		
	6.2 to 12.3 GHz, 2 kHz resolution band		_____	15 ms		
	12.4 to 18.0 GHz, 3 kHz resolution band		_____	15 ms		
4-9.	OUTPUT LEVEL, HIGH LEVEL ACCURACY AND FLATNESS TEST					
	Output Level					
	Frequency and Power at Minimum Power Point					
	2.0—18.0 GHz					
	Frequency _____					
	Minimum power	+8 dBm (or +3 dBm) ¹	_____			
	Level Flatness (total variation)					
	2.0—6.2 GHz		_____	1.50 dB		
	2.0—12.4 GHz		_____	2.00 dB		
	2.0—18.0 GHz		_____	2.50 dB		
	High Level Accuracy					
	+8 dBm (+10 dB range) ^{1,2}	2 GHz	+6.25 dBm	_____	+ 9.75 dBm	
		4 GHz	+6.25 dBm	_____	+ 9.75 dBm	
		6 GHz	+6.25 dBm	_____	+ 9.75 dBm	
		8 GHz	+6.00 dBm	_____	+10.00 dBm	
		10 GHz	+6.00 dBm	_____	+10.00 dBm	
		12 GHz	+6.00 dBm	_____	+10.00 dBm	
		14 GHz	+5.75 dBm	_____	+10.25 dBm	
		16 GHz	+5.75 dBm	_____	+10.25 dBm	
		18 GHz	+5.75 dBm	_____	+10.25 dBm	
		+3 dBm (+10 dB range)	2 GHz	+1.25 dBm	_____	+4.75 dBm
			4 GHz	+1.25 dBm	_____	+4.75 dBm
		6 GHz	+1.25 dBm	_____	+4.75 dBm	
		8 GHz	+1.00 dBm	_____	+5.00 dBm	
		10 GHz	+1.00 dBm	_____	+5.00 dBm	
		12 GHz	+1.00 dBm	_____	+5.00 dBm	
		14 GHz	+0.75 dBm	_____	+5.25 dBm	
		16 GHz	+0.75 dBm	_____	+5.25 dBm	
		18 GHz	+0.75 dBm	_____	+5.25 dBm	

¹ For serial number prefixes of 2640A and below (except Option 008), use +3 dBm. The maximum leveled and calibrated output power is +3 dBm.

² For serial number prefixes of 2640A and below (except Option 008), omit the High Level Accuracy check at +8 dBm.

Table 4-4. Performance Test Record (3 of 7)

Para. No.	Test	Results		
		Min.	Actual	Max.
4-9.	OUTPUT LEVEL, HIGH LEVEL ACCURACY AND FLATNESS TEST (cont'd)			
	High Level Accuracy (cont'd)			
	0 dBm (0 dB range)			
	2 GHz	-1.75 dBm	_____	+1.75 dBm
	4 GHz	-1.75 dBm	_____	+1.75 dBm
	6 GHz	-1.75 dBm	_____	+1.75 dBm
	8 GHz	-2.00 dBm	_____	+2.00 dBm
	10 GHz	-2.00 dBm	_____	+2.00 dBm
	12 GHz	-2.00 dBm	_____	+2.00 dBm
	14 GHz	-2.25 dBm	_____	+2.25 dBm
	16 GHz	-2.25 dBm	_____	+2.25 dBm
	18 GHz	-2.25 dBm	_____	+2.25 dBm
	-5 dBm (0 dB range)			
	2 GHz	-6.75 dBm	_____	-3.25 dBm
	4 GHz	-6.75 dBm	_____	-3.25 dBm
	6 GHz	-6.75 dBm	_____	-3.25 dBm
	8 GHz	-7.00 dBm	_____	-3.00 dBm
	10 GHz	-7.00 dBm	_____	-3.00 dBm
	12 GHz	-7.00 dBm	_____	-3.00 dBm
	14 GHz	-7.25 dBm	_____	-2.75 dBm
	16 GHz	-7.25 dBm	_____	-2.75 dBm
	18 GHz	-7.25 dBm	_____	-2.75 dBm
	-10 dBm (0 dB range)			
	2 GHz	-11.75 dBm	_____	-8.25 dBm
	4 GHz	-11.75 dBm	_____	-8.25 dBm
	6 GHz	-11.75 dBm	_____	-8.25 dBm
	8 GHz	-12.00 dBm	_____	-8.00 dBm
	10 GHz	-12.00 dBm	_____	-8.00 dBm
	12 GHz	-12.00 dBm	_____	-8.00 dBm
	14 GHz	-12.25 dBm	_____	-7.75 dBm
	16 GHz	-12.25 dBm	_____	-7.75 dBm
	18 GHz	-12.25 dBm	_____	-7.75 dBm
	-10 dBm (-10 dB range)			
	2 GHz	-12.25 dBm	_____	-7.75 dBm
	4 GHz	-12.25 dBm	_____	-7.75 dBm
	6 GHz	-12.25 dBm	_____	-7.75 dBm
	8 GHz	-12.50 dBm	_____	-7.50 dBm
	10 GHz	-12.50 dBm	_____	-7.50 dBm
	12 GHz	-12.50 dBm	_____	-7.50 dBm
	14 GHz	-12.85 dBm	_____	-7.15 dBm
	16 GHz	-12.85 dBm	_____	-7.15 dBm
	18 GHz	-12.85 dBm	_____	-7.15 dBm
	-20 dBm (-20 dB range)			
	2 GHz	-22.45 dBm	_____	-17.55 dBm
	4 GHz	-22.45 dBm	_____	-17.55 dBm
	6 GHz	-22.45 dBm	_____	-17.55 dBm
	8 GHz	-22.70 dBm	_____	-17.30 dBm
	10 GHz	-22.70 dBm	_____	-17.30 dBm

Table 4-4. Performance Test Record (4 of 7)

Para. No.	Test	Results		
		Min.	Actual	Max.
4-9.	OUTPUT LEVEL, HIGH LEVEL ACCURACY AND FLATNESS TEST (cont'd)			
	High Level Accuracy (cont'd)			
	-20 dBm (-20 dB range) (cont'd) 12 GHz	-22.70 dBm	_____	-17.30 dBm
	14 GHz	-23.05 dBm	_____	-16.95 dBm
	16 GHz	-23.05 dBm	_____	-16.95 dBm
	18 GHz	-23.05 dBm	_____	-16.95 dBm
4-10.	LOW LEVEL ACCURACY			
	2.0 GHz			
	-30 dBm	-32.65 dBm	_____	-27.35 dBm
	-40 dBm	-42.95 dBm	_____	-37.05 dBm
	-50 dBm	-53.25 dBm	_____	-46.75 dBm
	-60 dBm	-63.55 dBm	_____	-56.45 dBm
	-70 dBm	-73.85 dBm	_____	-66.15 dBm
	-80 dBm	-84.15 dBm	_____	-75.85 dBm
	-90 dBm	-94.45 dBm	_____	-85.55 dBm
	-100 dBm	-104.75 dBm	_____	-95.25 dBm
	-110 dBm	-115.05 dBm	_____	-104.95 dBm
	10.0 GHz			
	-30 dBm	-32.90 dBm	_____	-27.10 dBm
	-40 dBm	-43.20 dBm	_____	-36.80 dBm
	-50 dBm	-53.50 dBm	_____	-46.50 dBm
	-60 dBm	-63.80 dBm	_____	-56.20 dBm
	-70 dBm	-74.10 dBm	_____	-65.90 dBm
	-80 dBm	-84.40 dBm	_____	-75.60 dBm
	-90 dBm	-94.70 dBm	_____	-85.30 dBm
	-100 dBm	-105.00 dBm	_____	-95.00 dBm
	-110 dBm	-105.30 dBm	_____	-104.70 dBm
	18.0 GHz			
	-30 dBm	-33.45 dBm	_____	-26.55 dBm
	-40 dBm	-43.85 dBm	_____	-36.15 dBm
	-50 dBm	-54.25 dBm	_____	-45.75 dBm
	-60 dBm	-64.65 dBm	_____	-55.35 dBm
	-70 dBm	-75.05 dBm	_____	-64.95 dBm
	-80 dBm	-85.45 dBm	_____	-74.55 dBm
	-90 dBm	-95.95 dBm	_____	-84.15 dBm
	-100 dBm	-106.35 dBm	_____	-93.75 dBm
-110 dBm	-107.75 dBm	_____	-103.35 dBm	
4-11.	OUTPUT LEVEL SWITCHING TIME			
	<20 ms		_____	20 ms
4-12.	HARMONICS, SUBHARMONICS, AND MULTIPLES			
	Harmonic or Fundamental	Harmonic or Subharmonic		
	2.000000 GHz	4.000000 GHz 2f	_____	-25 dBc
	4.000000 GHz	8.000000 GHz 2f	_____	-25 dBc
	6.000000 GHz	12.000000 GHz 2f	_____	-25 dBc

Table 4-4. Performance Test Record (5 of 7)

Para. No.	Test	Results		
		Min.	Actual	Max.
4-12.	HARMONICS, SUBHARMONICS, AND MULTIPLES (cont'd)			
	Harmonic or Fundamental	Harmonic or Subharmonic		
	8.000 00 GHz	16.000 000 GHz 2f	_____	-25 dBc
	8.000 00 GHz	4.000 000 GHz 1/2f	_____	-25 dBc
	10.000 00 GHz	20.000 000 GHz 2f	_____	-25 dBc
	10.000 00 GHz	5.000 000 GHz 1/2f	_____	-25 dBc
	11.000 00 GHz	22.000 000 GHz 2f	_____	-25 dBc
	11.000 00 GHz	5.500 000 GHz 1/2f	_____	-25 dBc
	14.000 00 GHz	4.666 667 GHz 1/3f	_____	-25 dBc
	14.000 00 GHz	9.333 333 GHz 2/3f	_____	-25 dBc
	16.000 00 GHz	5.333 333 GHz 1/3f	_____	-25 dBc
	16.000 00 GHz	10.666 667 GHz 2/3f	_____	-25 dBc
	18.000 00 GHz	6.000 000 GHz 1/3f	_____	-25 dBc
	18.000 00 GHz	12.000 000 GHz 2/3f	_____	-25 dBc
4-13.	NON-HARMONICALLY RELATED SPURIOUS SIGNALS (CW AND AM MODES)			
	Carrier Frequency	Spurious Signal Frequency	Spurious Signal Level	
	2.0 to 6.2 GHz	_____	_____	-70 dBc
	3 000 MHz	_____	_____	-70 dBc
	_____	_____	_____	-70 dBc
	_____	_____	_____	-70 dBc
	_____	_____	_____	-70 dBc
4-14.	POWER LINE RELATED SPURIOUS SIGNALS			
		Offset Frequency		
	2.0—6.2 GHz			
	<300 Hz offset	_____	_____	-50 dBc
	300 Hz—1 kHz offset	_____	_____	-60 dBc
	>1 kHz offset	_____	_____	-65 dBc
	6.2—12.4 GHz			
	<300 Hz offset	_____	_____	-44 dBc
	300 Hz—1 kHz offset	_____	_____	-54 dBc
>1 kHz offset	_____	_____	-59 dBc	
12.4—18.0 GHz				
<300 Hz offset	_____	_____	-40 dBc	
300 Hz—1 kHz offset	_____	_____	-50 dBc	
>1 kHz offset	_____	_____	-55 dBc	

Table 4-4. Performance Test Record (6 of 7)

Para. No.	Test	Results		
		Min.	Actual	Max.
4-15.	SINGLE-SIDEBAND PHASE NOISE			
	10 Hz offset from carrier		_____	-58 dBc
	6100 MHz		_____	-52 dBc
	12 200 MHz		_____	-48 dBc
	18 000 MHz		_____	-70 dBc
	100 Hz offset from carrier	6100 MHz	_____	-64 dBc
	12 200 MHz		_____	-60 dBc
	18 000 MHz		_____	-78 dBc
	1 kHz offset from carrier	6100 MHz	_____	-72 dBc
	12 200 MHz		_____	-68 dBc
	18 000 MHz		_____	-86 dBc
	10 kHz offset from carrier	6100 MHz	_____	-80 dBc
12 200 MHz		_____	-76 dBc	
18 000 MHz		_____	-110 dBc	
	100 kHz offset from carrier	6100 MHz	_____	-104 dBc
	12 200 MHz		_____	-100 dBc
	18 000 MHz		_____	
4-16.	EXTERNAL FM ACCURACY AND METER ACCURACY			
	At 100 kHz rate			
	Meter Accuracy	210	_____	270 kHz-pk
	Accuracy relative to input level	0.53	_____	0.61 Vrms
4-17.	FM FREQUENCY RESPONSE			
	Relative to 100 kHz rate			
	3 kHz	-2.0 dB	_____	+2.0 dB
	30 kHz	-2.0 dB	_____	+2.0 dB
	300 kHz	-2.0 dB	_____	+2.0 dB
	1000 kHz	-2.0 dB	_____	+2.0 dB
	3000 kHz	-2.0 dB	_____	+2.0 dB
4-18.	FM HARMONIC AND NON-HARMONIC DISTORTION			
	<3 kHz		_____	12%
	20 kHz to 100 Hz		_____	5%
4-19.	RESIDUAL FM TEST			
	300 Hz to 3 kHz Post Detection Bandwidth			
	3 000 MHz		_____	16 Hz-rms
	12 200 MHz		_____	32 Hz-rms
	14 000 MHz		_____	48 Hz-rms
	50 Hz - 15 kHz Post Detection Bandwidth			
	3 000 MHz		_____	80 Hz-rms
	12 200 MHz		_____	160 Hz-rms
	14 000 MHz		_____	240 Hz-rms
4-20.	INCIDENTAL FM			
	10 kHz rate, 30% AM depth		_____	7 kHz

Table 4-4. Performance Test Record (7 of 7)

Para. No.	Test	Results		
		Min.	Actual	Max.
4-21.	AM DISTORTION For rates <10 kHz 30% AM Depth 50% AM Depth 75% AM Depth		_____ _____ _____	3% 4% 5%
4-22.	EXTERNAL AM ACCURACY AND METER ACCURACY Detected AM Signal 30% AM 75% AM 60% AM 50% AM AM Drive Signal 30% AM 75% AM 60% AM 50% AM	28.5% 70% 55% 45% 636 460 354 283	_____ _____ _____ _____ _____ _____ _____ _____	31.5% 80% 65% 55% 778 mVrms 601 mVrms 495 mVrms 424 mVrms
4-23.	AM BANDWIDTH 3 dB Bandwidth 10 Hz to 100 kHz	3.5 div.	_____	
4-24.	INCIDENTAL AM Rates ≤100 kHz, peak deviation ≤1 MHz 2 000 MHz 6 200 MHz 12 400 MHz		_____ _____ _____	10% 10% 10%
4-25.	INTERNAL TIME BASE AGING RATE		_____	5 x 10 ⁻¹⁰ /day

APPENDIX A MANUAL CHANGES

An instrument manufactured after the printing of this manual may have changes that require updating information. In this case, you will receive published material detailing the changes made. This material may consist of replacement pages or

additional pages and should be incorporated into the manual to bring it up to date. You may wish to keep the pages that are replaced with the updating information. This Appendix provides a place to file these pages.

